

# Cavity Bandpass Filters

50Ω DC to 15 GHz



## The Big Deal

- Very low insertion loss with excellent power handling
- Very fast roll-off with wide stopband
- Passbands up to 15 GHz
- Stopbands up to 20 GHz

## Product Overview

Mini-Circuits' cavity filters are designed by implementing resonant structures with very high Q and are ideal for narrow-band, high-selectivity applications. These designs can provide bandwidths as narrow as 1% with very high selectivity and excellent low noise floor. Low insertion loss combined with excellent power handling makes them well-suited for transmitter and receiver front end. Advanced filter design and construction enables stopband width greater than 3x the center frequency.

Mini-Circuits' cavity filters feature a special protective assembly to prevent accidental de-tuning that would otherwise require expensive replacement or return to factory for re-tuning. Precise machining allows realization of cavity filters with small form factors for applications where size is critical. Excellent repeatability across units is achieved through precise tuning and process control.

## Key Features

Feature	Advantages
Low insertion loss	Low signal loss results in better SNR in receiver front end and better power delivery to antenna in transmitter
Fast roll-off	Higher selectivity results in better adjacent channel rejection and dynamic range
Wide stopband	Wide spur free band results in better receiver sensitivity
High power handling	Well suited for transmitter application
Protective assembly	Prevents accidental de-tuning of precisely tuned resonant circuit

### Notes

- A. Performance and quality attributes and conditions not expressly stated in this specification document are intended to be excluded and do not form a part of this specification document.  
B. Electrical specifications and performance data contained in this specification document are based on Mini-Circuit's applicable established test performance criteria and measurement instructions.  
C. The parts covered by this specification document are subject to Mini-Circuits standard limited warranty and terms and conditions (collectively, "Standard Terms"); Purchasers of this part are entitled to the rights and benefits contained therein. For a full statement of the Standard Terms and the exclusive rights and remedies thereunder, please visit Mini-Circuits' website at [www.minicircuits.com/MCLStore/terms.jsp](http://www.minicircuits.com/MCLStore/terms.jsp)



# Bandpass Filter

## ZVBP-1575R42-S+

50Ω 1550.42 to 1600.42 MHz



### Features

- Good VSWR 1.19:1 typ @ center frequency
- Low insertion loss 0.7 dB typ @ center frequency
- High rejection
- Connectorized package

Generic photo used for illustration purposes only

CASE STYLE: UF2459

Connectors Model  
SMA-F ZVBP-1575R42-S+

### Electrical Specifications at 25°C

Parameter	F#	Frequency (MHz)	Min.	Typ.	Max.	Unit	
Pass Band	Center frequency	-	-	1575.42	-	MHz	
	3 dB Bandwidth	-	50	-	-	MHz	
	Insertion Loss	F1	1575.42	-	0.7	1.0	dB
	VSWR	F1	1575.42	-	1.19	1.29	:1
Stop Band, Lower	Insertion Loss	DC-F2	DC - 1475	60	68	-	dB
	VSWR	DC-F2	DC - 1475	-	20	-	:1
Stop Band, Upper	Insertion Loss	F3-F4	1675 - 3000	70	77	-	dB
	VSWR	F3-F4	1675 - 3000	-	20	-	:1

### Maximum Ratings

Operating Temperature	-40°C to 85°C
Storage Temperature	-55°C to 100°C
RF Power Input	20 W

Permanent damage may occur if any of these limits are exceeded.

### Typical Performance Data at 25°C

Frequency (MHz)	Insertion Loss (dB)	VSWR (:1)	Frequency (MHz)	Group Delay (nsec)
10.00	102.69	1288.33	1550.42	33.32
100.00	100.29	376.05	1553.00	29.52
600.00	104.76	187.43	1556.00	27.21
1000.00	101.83	211.51	1559.00	25.60
1475.00	68.09	261.43	1562.40	24.29
1527.00	30.03	88.64	1565.00	23.71
1534.20	20.21	45.82	1568.00	23.33
1544.40	3.06	3.06	1571.00	23.07
1550.42	0.90	1.13	1574.00	22.87
1562.40	0.71	1.17	1575.42	22.83
1575.42	0.67	1.13	1580.00	23.11
1582.40	0.67	1.07	1582.40	23.43
1600.42	0.92	1.14	1586.00	24.11
1608.00	3.12	2.87	1589.00	24.79
1617.00	20.63	32.40	1592.00	25.87
1623.00	30.45	50.94	1592.60	26.12
1675.00	76.76	137.36	1596.00	28.23
1700.00	94.91	161.08	1598.00	29.82
2000.00	100.61	299.19	1600.00	31.84
3000.00	104.83	298.07	1600.42	32.35

### Functional Schematic

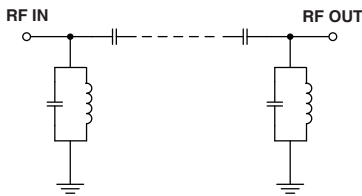

### Typical Frequency Response

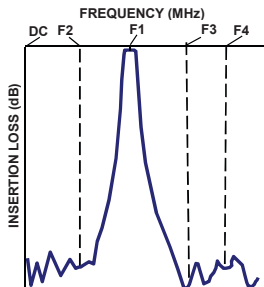

### +RoHS Compliant

The +Suffix identifies RoHS Compliance. See our web site for RoHS Compliance methodologies and qualifications

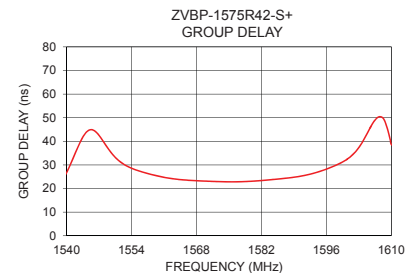
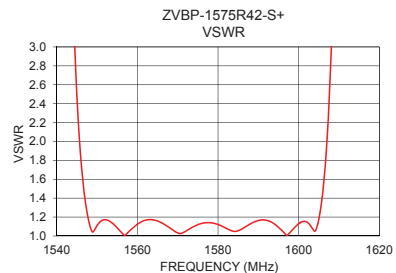
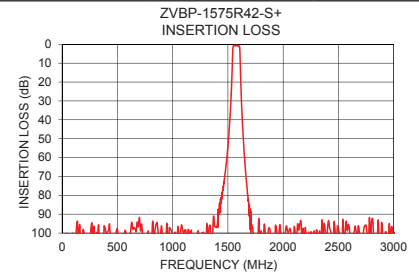
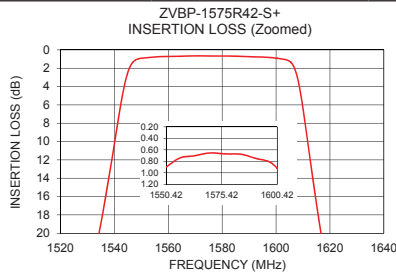

### Notes

- Performance and quality attributes and conditions not expressly stated in this specification document are intended to be excluded and do not form a part of this specification document.
- Electrical specifications and performance data contained in this specification document are based on Mini-Circuit's applicable established test performance criteria and measurement instructions.
- The parts covered by this specification document are subject to Mini-Circuits standard limited warranty and terms and conditions (collectively, "Standard Terms"); Purchasers of this part are entitled to the rights and benefits contained therein. For a full statement of the Standard Terms and the exclusive rights and remedies thereunder, please visit Mini-Circuits' website at [www.minicircuits.com/MCLStore/terms.jsp](http://www.minicircuits.com/MCLStore/terms.jsp)



## Coaxial Connections

PORT-1	SMA-Female
PORT-2	SMA-Female

## Outline Drawing

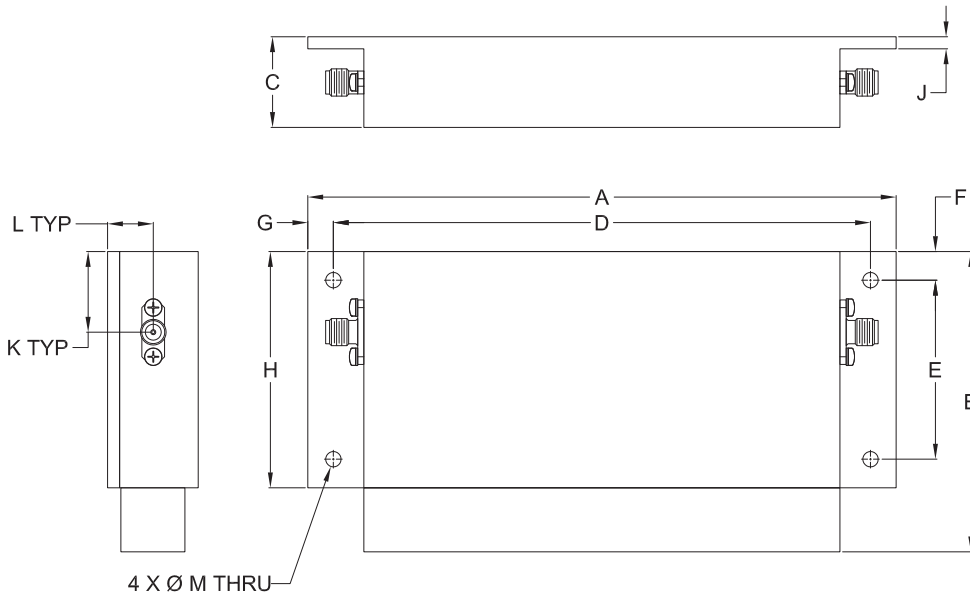

## Outline Dimensions (inch)

A	B	C	D	E	F	G
5.75	2.94	.89	5.250	1.750	.28	.25
146.04	74.55	22.50	133.35	44.45	7.11	6.34
H	J	K	L	M	Wt.	
2.31	.12	.79	.45	.140	grams	
58.67	3.00	20.02	11.34	3.56	267	

Note: Please refer to case style drawing for details

### Notes

- A. Performance and quality attributes and conditions not expressly stated in this specification document are intended to be excluded and do not form a part of this specification document.
- B. Electrical specifications and performance data contained in this specification document are based on Mini-Circuit's applicable established test performance criteria and measurement instructions.
- C. The parts covered by this specification document are subject to Mini-Circuits standard limited warranty and terms and conditions (collectively, "Standard Terms"); Purchasers of this part are entitled to the rights and benefits contained therein. For a full statement of the Standard Terms and the exclusive rights and remedies thereunder, please visit Mini-Circuits' website at [www.minicircuits.com/MCLStore/terms.jsp](http://www.minicircuits.com/MCLStore/terms.jsp)

