



CAVITY

# Bandpass Filter ZVBP MODEL SERIES

50Ω DC to 57 GHz

## THE BIG DEAL

- Very low insertion loss with excellent power handling
- Fast roll-off with wide stopband
- Passbands upto 36 GHz
- Stopband up to 57 GHz



## PRODUCT OVERVIEW

Mini-Circuits' cavity filters are designed by implementing resonant structures with very high Q and are ideal for narrow-band, high-selectivity applications. These designs can provide bandwidths as narrow as 0.5% with very high selectivity and excellent low noise floor. Low insertion loss combined with excellent power handling makes them well-suited for transmitter and receiver front end. Advanced filter design and construction enables stopband width greater than 3x the center frequency.

Mini-Circuits' cavity filters feature a special protective assembly to prevent accidental de-tuning that would otherwise require expensive replacement or return to factory for re-tuning. Precise machining allows realization of cavity filters with small form factors for applications where size is critical. Excellent repeatability across units is achieved through precise tuning and process control.

## KEY FEATURES

Feature	Advantages
Low insertion loss	Low signal loss results in better SNR in receiver front end and better power delivery to antenna in transmitter.
Fast roll-off	Higher selectivity results in better adjacent channel rejection and dynamic range
Wide stopband	Wide spur free band results in better receiver sensitivity
High power handling	Well suited for transmitter application
Protective assembly	Prevents accidental de-tuning of precisely tuned resonant circuit

REV. A  
ECO-015165  
ZVBP-11R175G-S+  
EDU2694  
URJ  
221001





CAVITY

# Bandpass Filter

## ZVBP-11R175G-S+

Mini-Circuits

50Ω 10575 to 11775 MHz SMA-Female

### FEATURES

- Low insertion loss, 0.4 dB typ.
- Good return loss, 18 dB typ.
- Great Rejection (40 to 100 dB typ.)
- Stopband up to 26500 MHz



Generic photo used for illustration purposes only

Model No.	ZVBP-11R175G-S+
Case Style	WN3325
Connectors	SMA-Female

### APPLICATIONS

- Test & Measurement Equipment
- Radar, EW, and ECM Defense Systems

**+RoHS Compliant**

The +Suffix identifies RoHS Compliance. See our web site for RoHS Compliance methodologies and qualifications

### ELECTRICAL SPECIFICATIONS AT 25°C

Parameter		F#	Frequency (MHz)	Min.	Typ.	Max.	Units
Passband	Center Frequency	Fc	—	—	11175	—	MHz
	Insertion Loss	F1-F2	10575 - 11775	—	0.4	0.7	dB
	Return Loss	F1-F2	10575 - 11775	14	18	—	dB
Stop Band, Lower	Rejection	DC-F3	DC - 8425	55	63	—	dB
		F3-F4	8425 - 9630	30	38	—	dB
Stop Band, Upper	Rejection	F5-F6	12700 - 13925	30	37	—	dB
		F6-F7	13925 - 26500	55	64	—	dB

### MAXIMUM RATINGS

Parameter	Ratings
Operating temperature	-40°C to +85°C
Storage temperature	-55°C to +100°C
RF Power Input	20W max. at 25°C

Permanent damage may occur if any of these limits are exceeded  
Input and output ports are DC short to ground.

### TYPICAL FREQUENCY RESPONSE

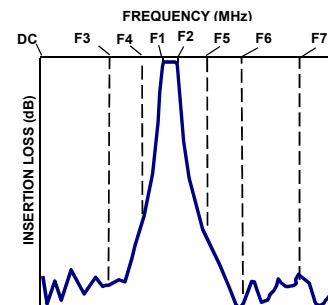

### FUNCTIONAL SCHEMATIC

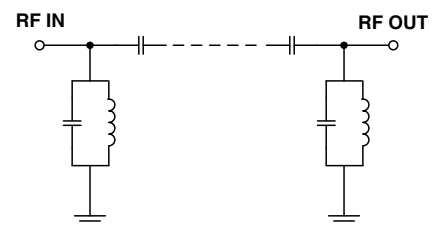

Mini-Circuits



CAVITY

# Bandpass Filter

## ZVBP-11R175G-S+

Mini-Circuits

### COAXIAL CONNECTIONS

PORT 1	SMA-Female
PORT 2	SMA-Female

### OUTLINE DRAWING

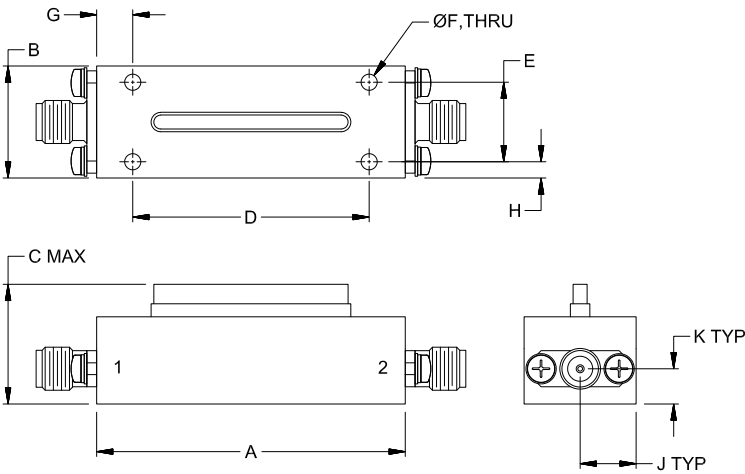

### OUTLINE DIMENSIONS (Inches) mm

A	B	C	D	E	F
<b>1.90</b>	<b>.69</b>	<b>.85</b>	<b>1.455</b>	<b>.490</b>	<b>.090</b>
48.3	17.5	21.6	36.96	12.45	2.29
G	H	J	K		Wt.
<b>.22</b>	<b>.10</b>	<b>.35</b>	<b>.22</b>		grams
5.7	2.5	8.8	5.5		37

Note. Please refer to case style drawing for details



CAVITY

# Bandpass Filter

# ZVBP-11R175G-S+

### TYPICAL PERFORMANCE DATA AT 25°C

Frequency (MHz)	Insertion Loss (dB)	Return Loss (dB)	Frequency (MHz)	GROUP DELAY (ns)
100	109.82	0.01	10575	1.23
1000	106.89	0.02	10600	1.17
8425	63.12	0.06	10700	1.05
10000	24.05	0.15	10850	0.96
10385	3.06	3.80	10900	0.94
10575	0.27	23.77	10950	0.92
10900	0.27	20.30	11000	0.91
11175	0.25	31.16	11050	0.91
11500	0.27	22.78	11100	0.91
11775	0.30	23.79	11150	0.91
11960	3.04	3.79	11175	0.91
12250	20.03	0.15	11200	0.91
12700	38.03	0.11	11250	0.91
13925	65.32	0.22	11350	0.92
26500	91.18	0.58	11775	1.24

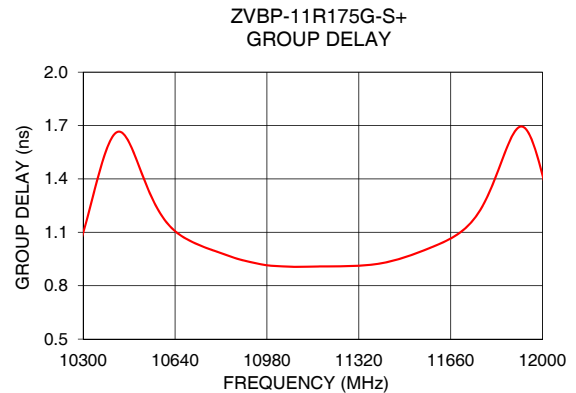
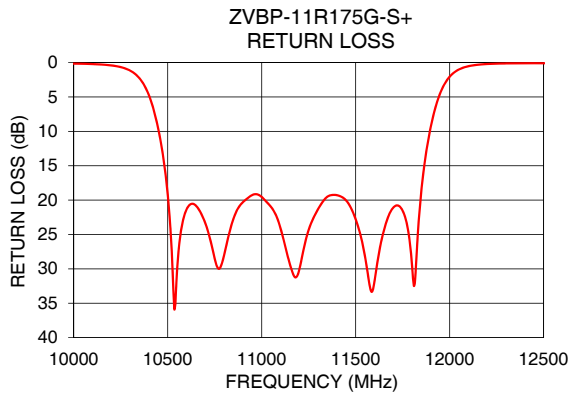
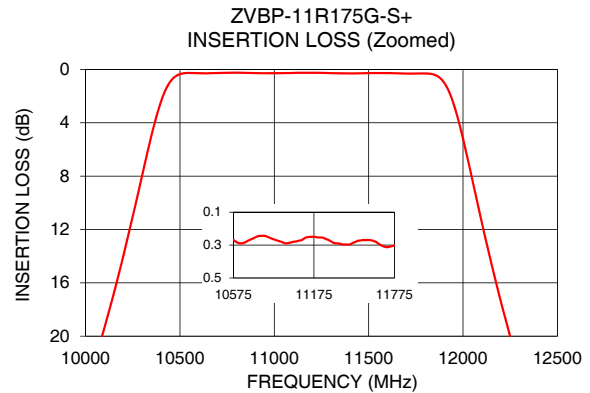
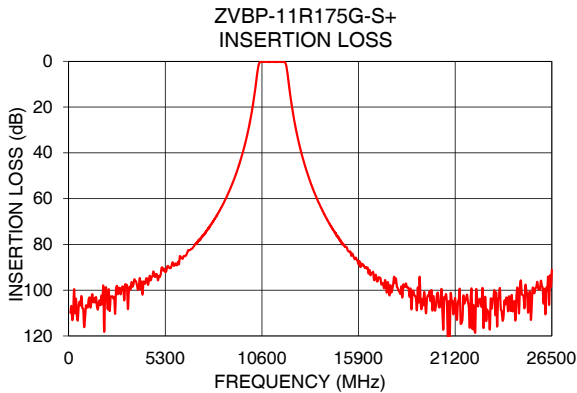

- NOTES**
- A. Performance and quality attributes and conditions not expressly stated in this specification document are intended to be excluded and do not form a part of this specification document.
  - B. Electrical specifications and performance data contained in this specification document are based on Mini-Circuit's applicable established test performance criteria and measurement instructions.
  - C. The parts covered by this specification document are subject to Mini-Circuits standard limited warranty and terms and conditions (collectively, "Standard Terms"); Purchasers of this part are entitled to the rights and benefits contained therein. For a full statement of the standard. Terms and the exclusive rights and remedies thereunder, please visit Mini-Circuits' website at [www.minicircuits.com/MCLStore/terms.jsp](http://www.minicircuits.com/MCLStore/terms.jsp)

