

RACK-MOUNTED

SMA Adapter Patch Panel

ZT-346

Mini-Circuits

50Ω DC to 18 GHz

THE BIG DEAL

- Convenient panel-mounted design
- Excellent VSWR
- Flat frequency response



CASE STYLE: YF3183

APPLICATIONS

- Production test set-ups
- Simplification of cable runs
- Interconnection of RF cables & equipment

RoHS Compliant
See our website for RoHS Compliance methodologies and qualifications

PRODUCT OVERVIEW

Mini-Circuits panel-mounted structures provide clean, organized management of cable runs and connections in complex, high-volume test setups. Multiple connector adapters, power splitters, directional couplers and other essential RF components and test accessories can be integrated efficiently within the test system. Custom configurations are available upon request. ZT-346 is a 1U height patch panel incorporating 12 high quality connector adaptors, with SMA female connectors on the front and rear of the panel.

ELECTRICAL SPECIFICATIONS AT 25°C

Parameter	Frequency (GHz)	Min.	Typ.	Max.	Unit
Frequency	-	DC	-	18	GHz
Insertion Loss	DC - 18	-	0.1	-	dB
VSWR	DC - 18	-	-	1.15	:1

MECHANICAL & ENVIRONMENTAL SPECIFICATIONS

Dimensions	19" (W) x 1U (H)				
Case Style	YF3183				
Case Material	Aluminum (with protective coating to prevent corrosion)				
RF Connectors	Face	Connector	Quantity	Port Labels	
	Front	SMA female	12	01-12	
	Rear	SMA female	12	None	
Panel Marking	Front Panel	Rear Panel			
	<ul style="list-style-type: none"> • ZT-346 	<ul style="list-style-type: none"> • CE / EAC / UKCA • Serial number / date code / model name 			
Panel Items	<ul style="list-style-type: none"> • Carry handles 				
Temperature	Operating: 0 to +50 °C				

REV. A
ECO-013880
ZT-346
MCL NY
220623



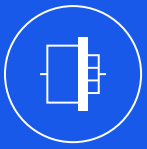

RACK-MOUNTED

SMA Adapter Patch Panel

ZT-346

Mini-Circuits

50Ω DC to 18 GHz

TYPICAL PERFORMANCE CURVES

Frequency (MHz)	Insertion Loss (dB)	VSWR (:1)	
		SMA-FEM	SMA-FEM
10	0.01	1.00	1.00
50	0.00	1.00	1.00
100	0.00	1.00	1.00
500	0.01	1.01	1.01
1000	0.03	1.02	1.02
1500	0.03	1.02	1.02
2000	0.04	1.03	1.03
2500	0.04	1.03	1.03
3000	0.04	1.03	1.04
4000	0.04	1.03	1.03
5000	0.04	1.02	1.02
6000	0.04	1.02	1.02
9000	0.07	1.09	1.09
10000	0.08	1.11	1.11
12000	0.09	1.10	1.09
13000	0.08	1.09	1.08
14000	0.08	1.04	1.04
15000	0.10	1.03	1.03
17000	0.12	1.09	1.09
18000	0.11	1.12	1.13

ZT-346
INSERTION LOSS

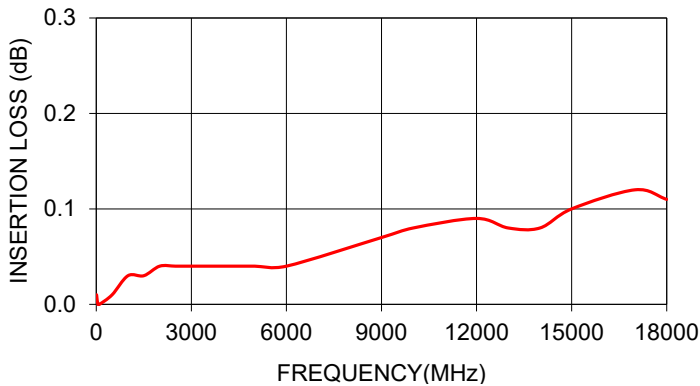

ZT-346
VSWR

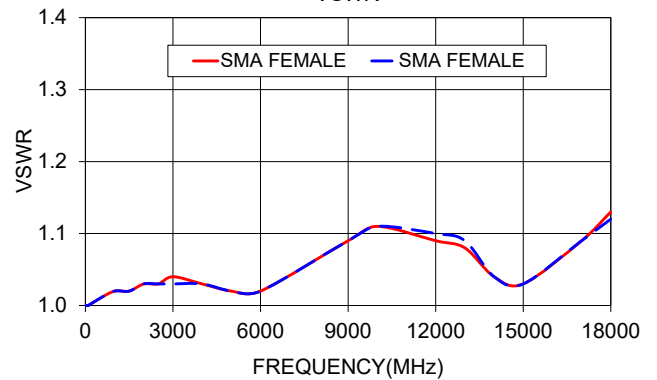

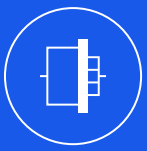

RACK-MOUNTED

SMA Adapter Patch Panel

ZT-346

Mini-Circuits

50Ω DC to 18 GHz

OUTLINE DRAWING

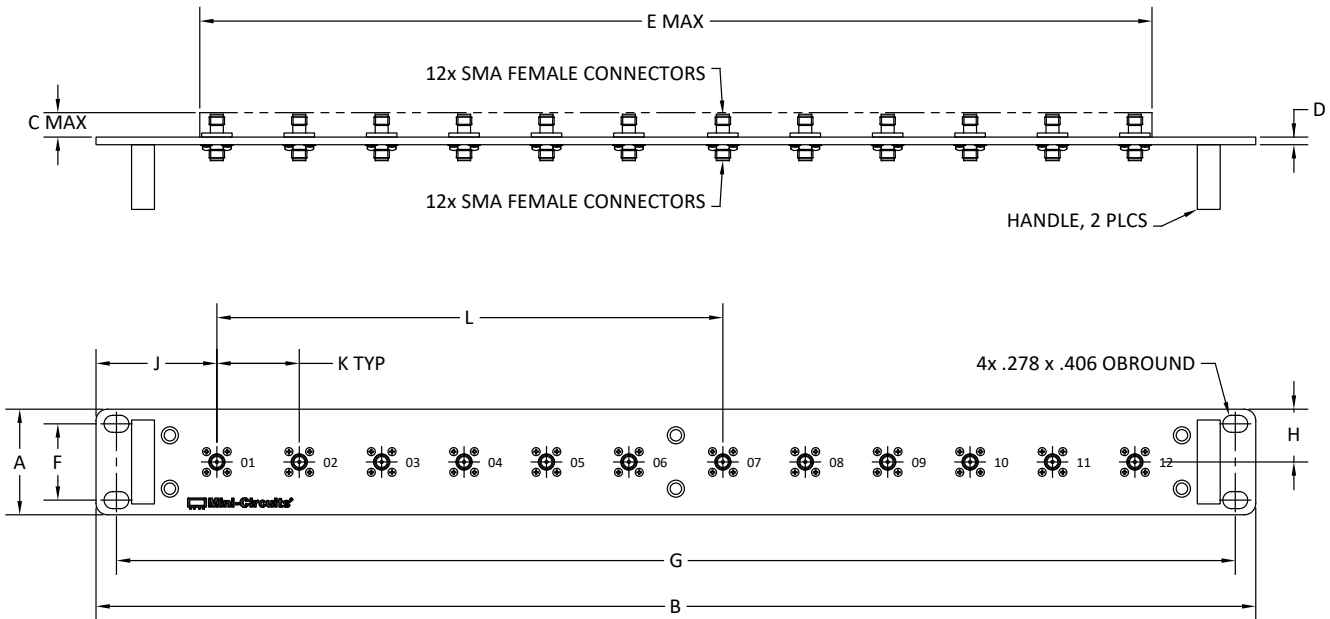
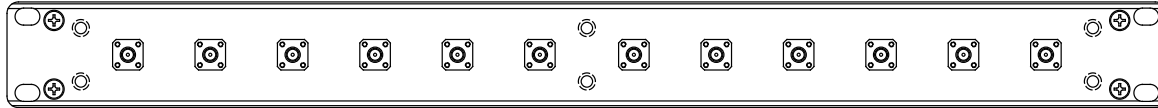

OUTLINE DIMENSIONS (Inch mm)

A	B	C	D	E	F	G	H	J	K	L	wt
1.73	19.00	0.40	0.13	15.60	1.250	18.340	0.87	1.98	1.35	8.29	grams
43.9	482.6	10.2	3.30	396.24	31.8	465.8	22.10	50.3	34.3	210.6	240





RACK-MOUNTED

SMA Adapter Patch Panel

ZT-346

Mini-Circuits

50Ω DC to 18 GHz

ORDERING INFORMATION

To learn more, click here: [ZT-346](#)

Model	Description
ZT-346	12 x SMA female to female patch panel

Included Accessories	Part No.	Description
	HT-4-SMA	SMA Cable Wrench (4 in)