

Suspended Substrate Stripline Filters and Multiplexers

50Ω DC to 26 GHz

The Big Deal

- Low insertion loss
- Ultra-wide passband width
- Fast roll-off with wide stopband
- Good power handling and temperature stability
- Passband up to 26 GHz
- Stopband up to 26.5 GHz can extend to 40 GHz



Product Overview

Mini-Circuits' Suspended Substrate Stripline filters offer low insertion loss by implementing printed circuit board suspended between two parallel ground planes, providing high Q. Low insertion loss combined with wide stopband makes them an excellent choice for wideband instruments and systems like ECM, ECCM, ELINT and ultra-broadband receivers.

Low pass, high pass, band pass, band stop, diplexer and multiplexer designs can be realized with this technology. Advanced filter design and construction can achieve stopband width greater than 6x the center frequency, and temperature stability will be better than other printed circuit realizations because the fields are mainly in the air rather than in a dielectric. The inside walls of the housing hold the circuit and prevent movement that could be caused by vibration or mechanical shock, making these designs excellent candidates for harsh operating environments.

Suspended substrate stripline filters can be realized in small form factors with high-quality, precise machining for applications where size is critical. Excellent repeatability across units is achieved through precise tuning and process control.

Key Features

Feature	Advantages
Low insertion loss	Low signal loss results in better SNR in receiver front end and better power delivery to antenna in transmitters
Fast roll-off	Higher selectivity results in better adjacent channel rejection and dynamic range
Wide stopband	Wide, spur-free stop band results in better receiver sensitivity
High power handling	Well suited for transmitter applications
Excellent temperature stability	Ensures minimal variation in electrical performance across temperature

Notes

- A. Performance and quality attributes and conditions not expressly stated in this specification document are intended to be excluded and do not form a part of this specification document.
B. Electrical specifications and performance data contained in this specification document are based on Mini-Circuit's applicable established test performance criteria and measurement instructions.
C. The parts covered by this specification document are subject to Mini-Circuits standard limited warranty and terms and conditions (collectively, "Standard Terms"); Purchasers of this part are entitled to the rights and benefits contained therein. For a full statement of the Standard Terms and the exclusive rights and remedies thereunder, please visit Mini-Circuits' website at www.minicircuits.com/MCLStore/terms.jsp



Suspended substrate stripline Band Pass Filter

ZBSS-4G-S+

50Ω 2000 to 6000 MHz



Generic photo used for illustration purposes only

CASE STYLE:WF3308

Connectors Model

SMA - F ZBSS-4G-S+

Features

- Wide fractional bandwidth design of 100%
- 0.8dB typ. Insertion Loss at Center frequency
- Sharp roll-off
- High rejection floor of 90dB typ.
- Stop band up to 26.5 GHz
- Connectorized package

Applications

- Satellite communications
- Radiolocation
- Radio Navigation
- Maritime Mobile
- Military and defense
- Electronic warfare receiver
- Wideband receivers
- Space Research

Functional Schematic

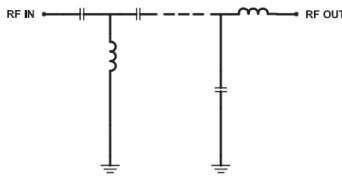

Typical Frequency Response

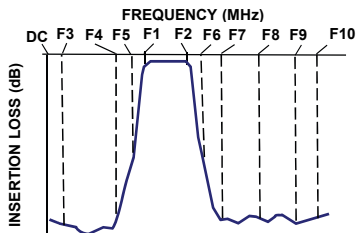

Electrical Specifications at 25°C

Parameter	F#	Frequency (MHz)	Min.	Typ.	Max.	Unit	
Pass Band	Center Frequency	Fc	4000	-	0.8	-	dB
	Insertion Loss	F1-F2	2000 - 6000	-	1.3	2.5	dB
	VSWR	F1-F2	2000 - 6000	-	1.4	-	:1
Stop Band, Lower	Insertion Loss	DC-F3	DC - 1100	60	90	-	dB
		F3-F4	1100 - 1300	40	60	-	dB
		F4-F5	1300 - 1400	20	40	-	dB
Stop Band, Upper	Insertion Loss	F6-F7	8000 - 9100	20	40	-	dB
		F7-F8	9100 - 11000	40	60	-	dB
		F8-F9	11000 - 25000	60	90	-	dB
		F9-F10	25000 - 26500	-	90	-	dB

Maximum Ratings

Operating Temperature	-40°C to 85°C
Storage Temperature	-55°C to 100°C
RF Power Input	5W max. @ 25°C

Permanent damage may occur if any of these limits are exceeded.

Typical Performance Data at 25°C

Frequency (MHz)	Insertion Loss (dB)	VSWR (:1)	Frequency (MHz)	Group Delay (nsec)
10	103.89	4698.89	2000	1.83
100	118.63	2567.13	2200	1.33
1100	83.53	129.91	2400	1.11
1300	57.74	70.59	2600	0.98
1400	44.50	47.90	2800	0.89
1550	22.35	18.58	3000	0.82
1700	2.66	1.31	3200	0.78
2000	1.18	1.22	3400	0.74
3000	0.71	1.25	3600	0.71
4000	0.70	1.36	3800	0.69
5000	0.68	1.19	4000	0.68
6000	0.97	1.15	4200	0.67
6400	3.20	2.70	4400	0.66
6950	20.17	33.48	4600	0.66
7300	30.12	45.28	4800	0.66
8000	45.40	51.58	5000	0.67
9100	62.23	109.67	5200	0.68
11000	85.02	297.56	5400	0.69
25000	107.35	8.62	5600	0.72
26500	103.35	2.01	6000	0.84

+RoHS Compliant

The +Suffix identifies RoHS Compliance. See our web site for RoHS Compliance methodologies and qualifications

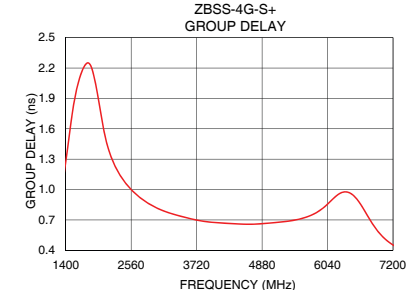
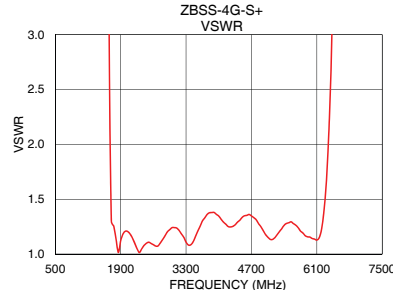
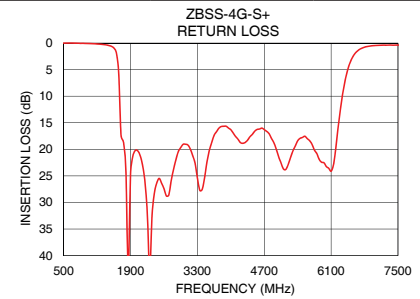
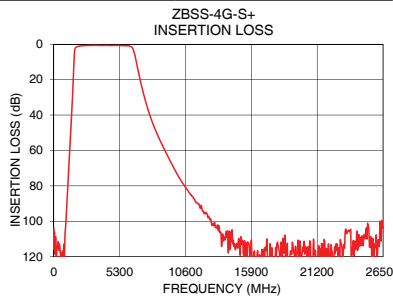

Notes

- Performance and quality attributes and conditions not expressly stated in this specification document are intended to be excluded and do not form a part of this specification document.
- Electrical specifications and performance data contained in this specification document are based on Mini-Circuit's applicable established test performance criteria and measurement instructions.
- The parts covered by this specification document are subject to Mini-Circuit's standard limited warranty and terms and conditions (collectively, "Standard Terms"); Purchasers of this part are entitled to the rights and benefits contained therein. For a full statement of the Standard Terms and the exclusive rights and remedies thereunder, please visit Mini-Circuit's website at www.minicircuits.com/MCLStore/terms.jsp



Coaxial Connections

PORT - 1	SMA FEMALE
PORT - 2	SMA FEMALE

Outline Drawing

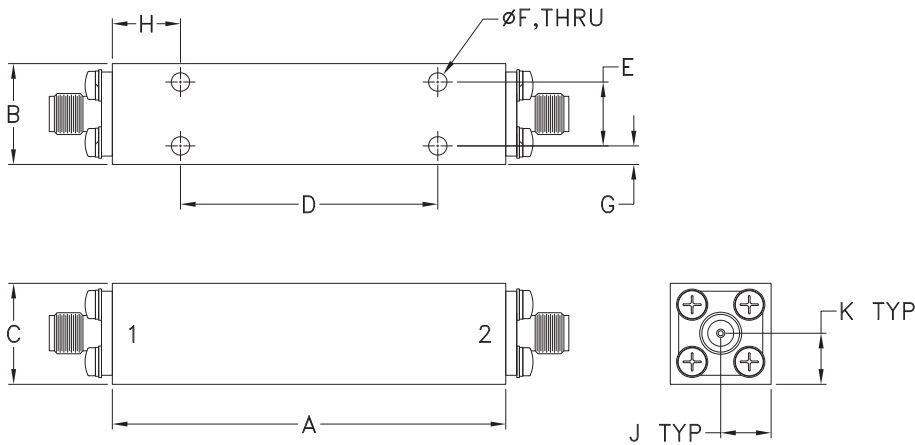

Outline Dimensions ($\frac{\text{inch}}{\text{mm}}$)

A	B	C	D	E	F
2.34	.60	.60	1.530	.380	.110
59.44	15.2	15.2	38.86	9.65	2.79
G	H	J	K	Wt.	
.11	.41	.30	.30	grams	
2.8	10.3	7.6	7.7	108	

Note: Please refer to case style drawing for details

Notes

- A. Performance and quality attributes and conditions not expressly stated in this specification document are intended to be excluded and do not form a part of this specification document.
- B. Electrical specifications and performance data contained in this specification document are based on Mini-Circuit's applicable established test performance criteria and measurement instructions.
- C. The parts covered by this specification document are subject to Mini-Circuits standard limited warranty and terms and conditions (collectively, "Standard Terms"); Purchasers of this part are entitled to the rights and benefits contained therein. For a full statement of the Standard Terms and the exclusive rights and remedies thereunder, please visit Mini-Circuits' website at www.minicircuits.com/MCLStore/terms.jsp

