



SP4T Switch

USB-2SP4T-852H

50Ω

10 to 8500 MHz

SMA female

THE BIG DEAL

- 2 x independent SP4T switches
- High-speed switch transition, 5 μs
- Very high isolation, 60 dB
- High power handling, +30 dBm max
- Daisy-chain control of up to 35 modules

APPLICATIONS

- High volume production testing / ATE
- 5G FR1, WiFi 6E, Bluetooth testing
- Design verification testing
- RF signal routing / switch matrices

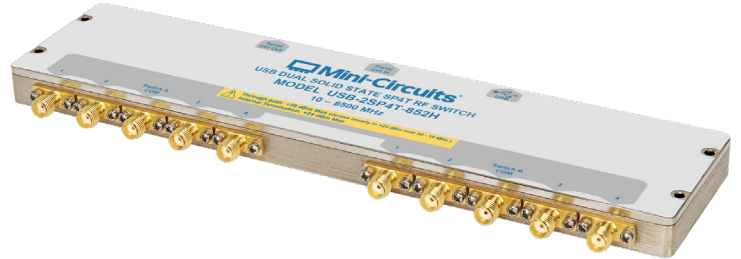

Generic photo used for illustration purposes only

PRODUCT OVERVIEW

Mini-Circuits' USB-2SP4T-852H is a low cost, USB controlled, solid state matrix, containing two independent SP4T RF switches. The fast switching, absorptive switch operates from 10 MHz to 8500 MHz with 5 μs typical switch transition speed. High linearity (+50 dBm typ IP3) and high isolation (60 dB typical) allow the model to be used for a wide variety of RF applications.

The USB-2SP4T-852H is housed in a compact, low profile, rugged metal case (8.4" x 2.0" x 0.475") with 10 SMA (F) connectors (COM, 1 to 4 for each switch), a USB Mini-B port for power and control, and two data bus connectors for Master / Slave connections to other modules.

Full software support is provided, including our user-friendly GUI application for Windows and a full API with programming instructions for Windows and Linux environments (both 32-bit and 64-bit systems).

KEY FEATURES

Feature	Advantages
Two RF SP4T absorptive switches	Wideband (10 to 8500 MHz) with low insertion loss (3 dB typ.), high isolation (60 dB typ), and high power rating (+30 dBm through path).
High Linearity (IP3 +50 dBm typ.)	Excellent intermodulation performance, meeting requirements for digital communications signals.
Internal DC Blocking capacitors	No need for external DC blocking circuitry.
Dynamic daisy-chain control	Simplify control software and interconnections by cascading up to 35 modules of multiple switch types into a Master / Slave chain with a single USB interface.
Full software support	User friendly Windows GUI (graphical user interface) allows manual control straight out of the box, while the comprehensive API (application programming interface) with examples and instructions allows easy automation in most programming environments.

Trademarks:

Windows is a registered trademark of Microsoft Corporation in the United States and other countries ; Linux is a registered trademark of Linus Torvalds ; Pentium is a registered trademark of Intel Corporation. Neither Mini-Circuits nor the Mini-Circuits products are affiliated with or endorsed by the owners of the referenced trademarks. Mini-Circuits and the Mini-Circuits logo are registered trademarks of Scientific Components Corporation.



SP4T Switch

USB-2SP4T-852H

ELECTRICAL SPECIFICATIONS AT -10 TO 60°C

Parameter	Ports	Condition (MHz)	Min.	Typ.	Max.	Unit
Frequency range	-	-	10		8500	MHz
Insertion loss	COM to any active port	10 - 700	-	2.1	3.5	dB
		700 - 2500	-	2.5	4.0	
		2500 - 5000	-	2.9	4.3	
		5000 - 6000	-	3.3	4.7	
		6000 - 7200	-	3.7	6.0	
		7200 - 8000	-	4.3	6.5	
		8000 - 8500	-	5.0	7.0	
Isolation	Between ports J1 to J4 (of any given switch)	10 - 700	78	105	-	dB
		700 - 2500	74	105	-	
		2500 - 5000	63	90	-	
		5000 - 6000	58	80	-	
		6000 - 7200	58	72	-	
		7200 - 8000	57	67	-	
		8000 - 8500	50	60	-	
	COM to any terminated port (of any given switch)	10 - 700	77	105	-	
		700 - 2500	73	100	-	
		2500 - 5000	60	79	-	
		5000 - 6000	58	70	-	
		6000 - 7200	55	64	-	
		7200 - 8000	50	60	-	
		8000 - 8500	45	57	-	
	Disconnected state (COM port open) ¹ : COM to J1, J2, or J4 (of any given switch)	10 - 700	77	105	-	
		700 - 2500	73	100	-	
		2500 - 5000	60	79	-	
		5000 - 6000	58	70	-	
		6000 - 7200	55	64	-	
		7200 - 8000	50	60	-	
		8000 - 8500	45	57	-	
	Disconnected state (COM port open) ¹ : COM to J3 (of any given switch)	10 - 700	55	70	-	
		700 - 2500	37	48	-	
		2500 - 5000	30	39	-	
		5000 - 6000	28	36	-	
		6000 - 7200	24	34	-	
		7200 - 8000	21	33	-	
	8000 - 8500	18	32	-		
Crosstalk between switches		10 - 8500	85	100	-	

1. In the "disconnected" state, COM is open (reflective) and ports J1-J4 are absorptive. COM to J3 isolation is lower than the other paths due to the internal switch configuration (refer to block diagram for details).



ELECTRICAL SPECIFICATIONS AT -10 TO 60°C (CONTINUED)

Parameter	Ports	Condition (MHz)	Min.	Typ.	Max.	Unit
Return loss	COM port (active states)	10 - 2500	-	19.0	-	dB
		2500 - 5000	-	14.5	-	
		5000 - 6000	-	15.5	-	
		6000 - 7200	-	15.0	-	
		7200 - 8000	-	10.0	-	
		8000 - 8500	-	7.0	-	
	Any port connected to COM	10 - 5000	-	19.0	-	
		5000 - 6000	-	17.5	-	
		6000 - 7200	-	13.5	-	
		7200 - 8000	-	10.0	-	
	Any terminated port	8000 - 8500	-	8.5	-	
		10 - 2500	-	21.0	-	
		2500 - 5000	-	19.0	-	
		5000 - 8000	-	15.5	-	
			8000 - 8500	-	12.0	
Power input @1 dB compression ^{2,3}	COM to any active port	100 - 8500	-	+33	-	dBm
IP3 ^{3,4}	COM to any active port	100 - 8500	-	+50	-	dBm
Transition time ⁵	-	-	-	5	8	μs
Minimum dwell time ⁶	High-speed mode	-	-	15	-	μs
Switching time (USB) ⁷	-	-	-	2	-	ms
Supply voltage (Vcc)	USB port	-	4.75	5	5.25	V _{DC}
Supply current (Icc)		-	-	55	85	mA
Operating RF input power ⁸	Per port (COM & J1 - J4)	Hot switching	10 - 8500	-	-	+24
	Total on any through path (bi-directional)	Cold switching	10 - 50	-	-	Note 2
			50 - 6000	-	-	+30
				6000-8500	-	-
	Per terminated port (J1 - J4)	Into internal termination	10 - 8500	-	-	+24

2. Max power at through path derates linearly from +30 dBm @ 50 MHz to +25 dBm @ 10 MHz.

3. Compression and IP3 may degrade below 100 MHz.

4. IP3 tested with 1 MHz span between signals, +5 dBm per tone.

5. Transition time spec represents the time that the RF signal paths are interrupted during switching and thus is specified without communication delays.

6. Minimum dwell time is the shortest time that can be achieved between 2 switch transitions when programming an automated switch sequence.

7. Switching time(USB) is the time from issuing a single software command via USB to the switch state changing. The most significant factor is the host PC, influenced by CPU load and USB protocol. The time shown is an estimate for a medium CPU load and USB 2.0 connection.

8. The switch can tolerate the max cold switching power on the active path simultaneously with the max internal termination power on every terminated port.

ABSOLUTE MAXIMUM RATINGS ⁹

Operating temperature	-10°C to 60°C
Storage temperature	-20°C to 85°C
DC supply voltage max @ USB and pin 4 of D-sub	6V
DC voltage @ RF ports	16V

9. Permanent damage may occur if any of these limits are exceeded. Operating in the range between operating power limits and absolute maximum ratings for extended periods of time may result in reduced life and reliability.



TYPICAL PERFORMANCE GRAPHS

Insertion Loss over Temperature (J1 Active)

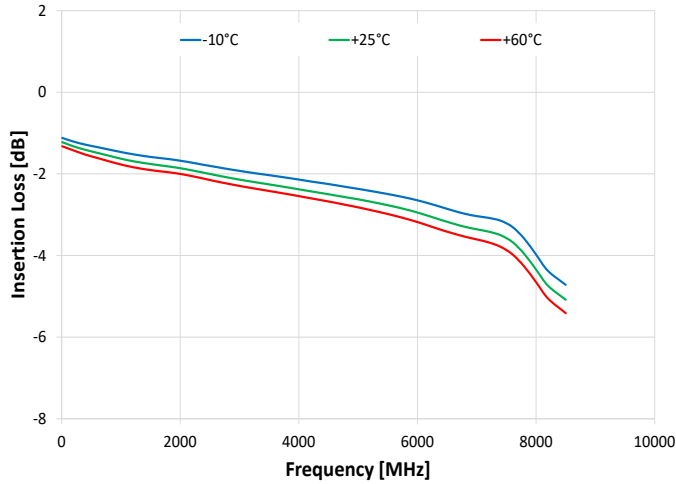

Insertion Loss J1 - J4 Active

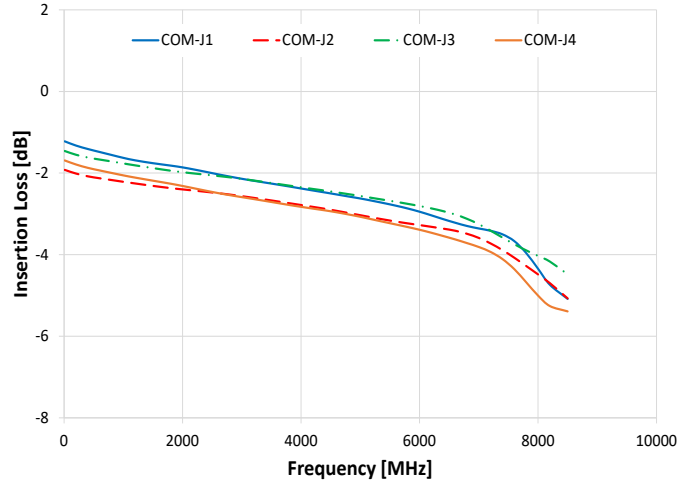

Isolation Com to J1 (J2 Active)

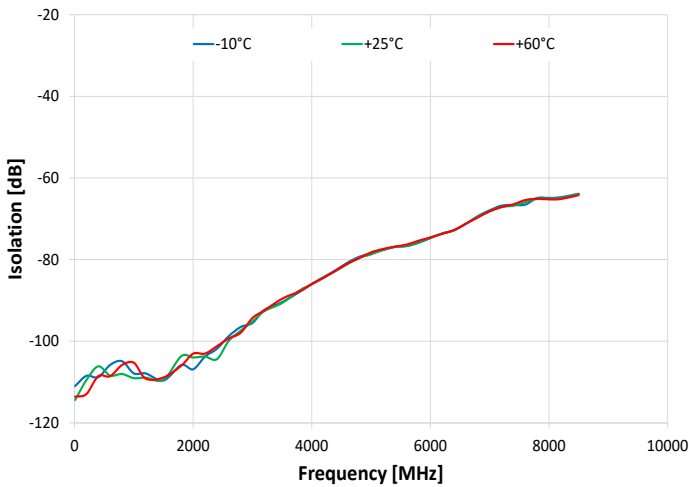

Isolation Com to J3 (J4 Active)

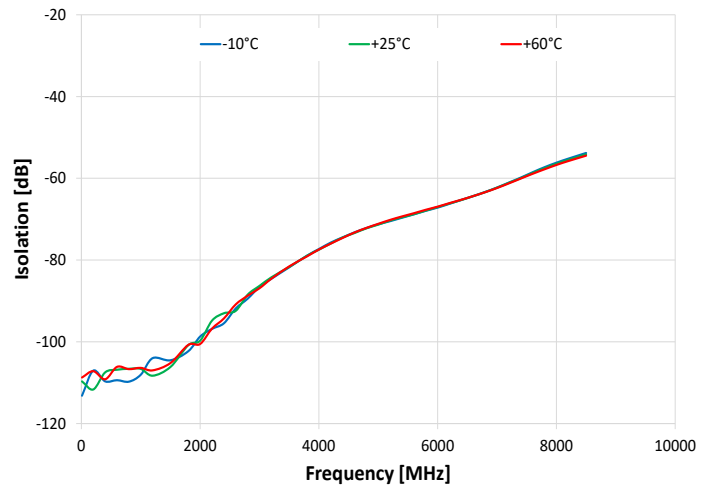

Isolation J2 to J3 (J2 Active)

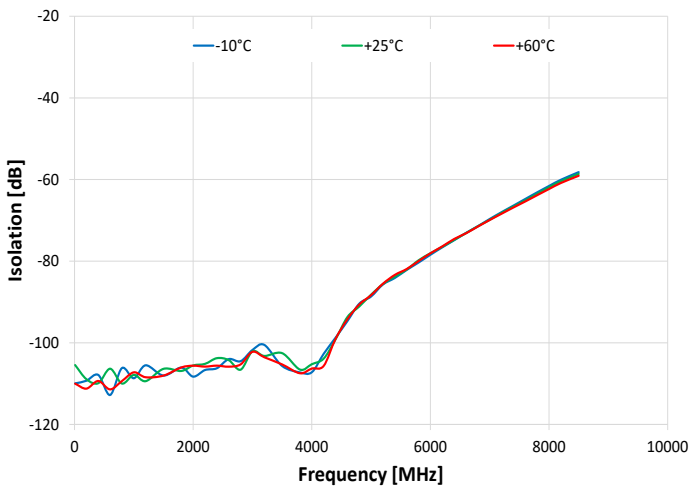

Isolation J3 to J4 (J3 Active)

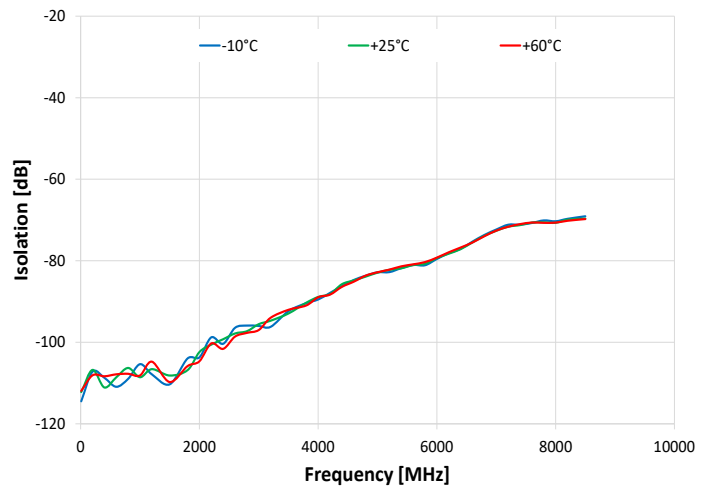



TYPICAL PERFORMANCE GRAPHS (CONTINUED)

Return Loss @ COM over Temperature (J1 Active)

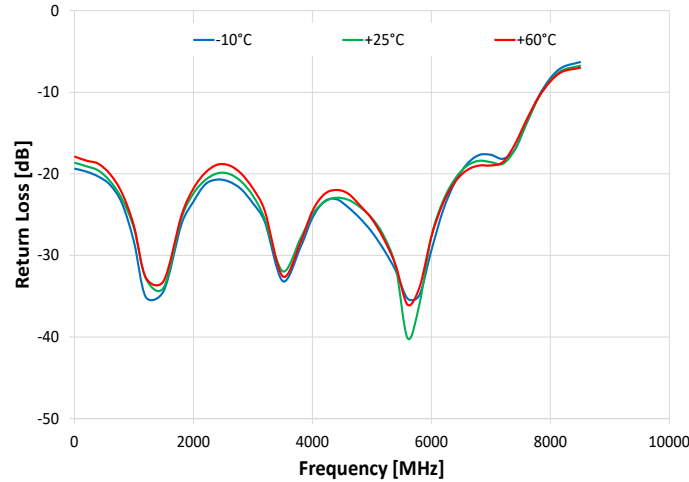

Return Loss @ J1 over Temperature (J1 Active)

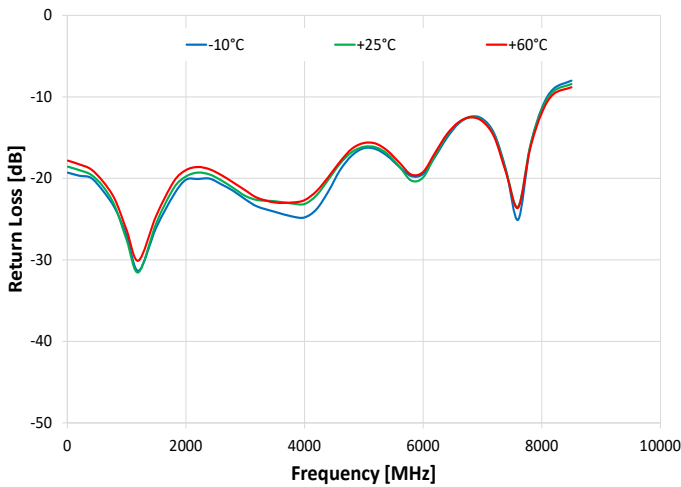

Return Loss @ J1 over Temperature (J1 Terminated)

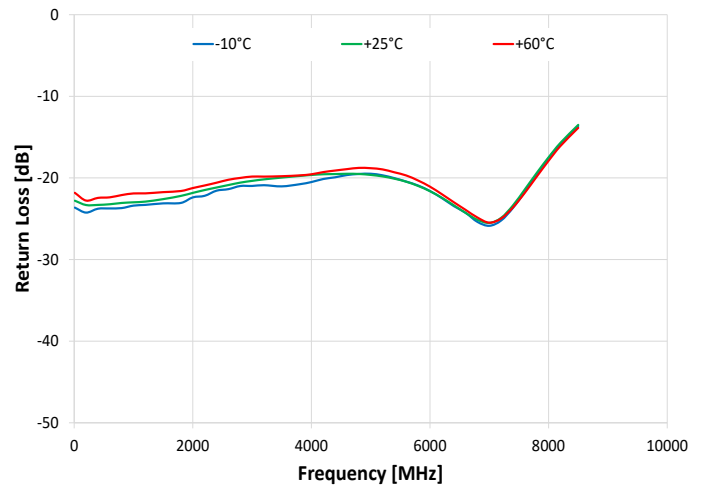

Return Loss @ Active ports (J1- J4 Active)

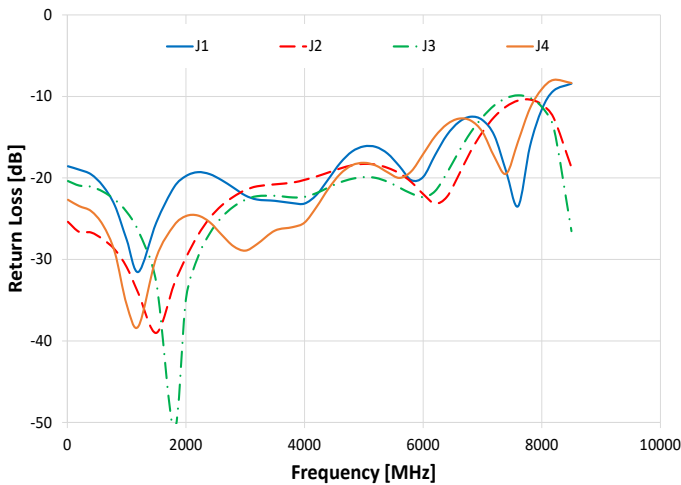

Return Loss @ Terminated ports (J1 - J4 Terminated)

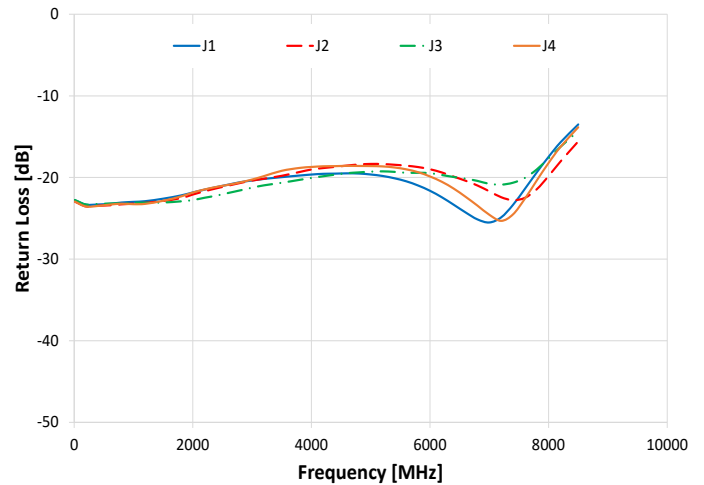



CONTROL INTERFACES

USB control	Supported protocols	HID (Human Interface Device) - Full-speed
	Min communication time ¹⁰	3 ms typ (full transmit/receive cycle)

10. USB min communication time is based on the polling interval of the USB HID protocol (1 ms polling interval, 64 bytes per packet), medium CPU load and no other high speed USB devices using the USB bus.

SOFTWARE & DOCUMENTATION

Mini-Circuits' full software and support package including user guide, Windows GUI, API, programming manual and examples can be downloaded free of charge (refer to the last page for the download path).

A comprehensive set of software control options is provided:

- GUI for Windows – Simple software interface for control via Ethernet and USB.
- Programming / automation via USB:
 - DLL files provide a full API for Windows with a set of intuitive functions which can be implemented in any programming environment supporting .Net Framework or ActiveX.
 - Direct USB programming is possible in any other environment (not supporting .Net or ActiveX).

Please contact testsolutions@minicircuits.com for support.

MINIMUM SYSTEM REQUIREMENTS

GUI	Windows 7 or later
USB API DLL	Windows 7 or later and programming environment with ActiveX or .NET support
USB Direct Programming	Linux, Windows 7 or later
Daisy-chain dynamic addressing	An additional Mini-Circuits model supporting dynamic addressing
Hardware	Intel i3 (or equivalent) or later



GRAPHICAL USER INTERFACE (GUI) FOR WINDOWS - KEY FEATURES

- Connect via USB
- Run GUI in "demo mode" to evaluate software without a hardware connection

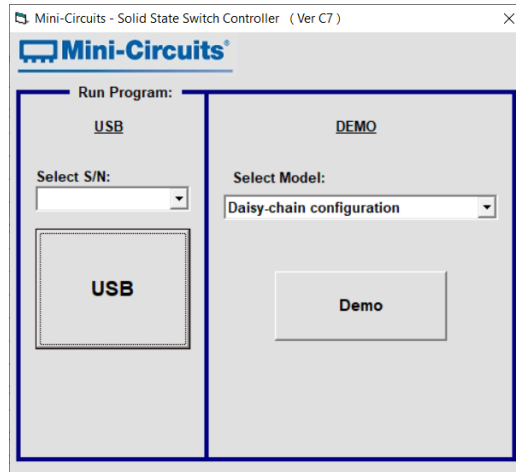

- View and set switch states at the click of a button
- Configure and run timed switching sequences

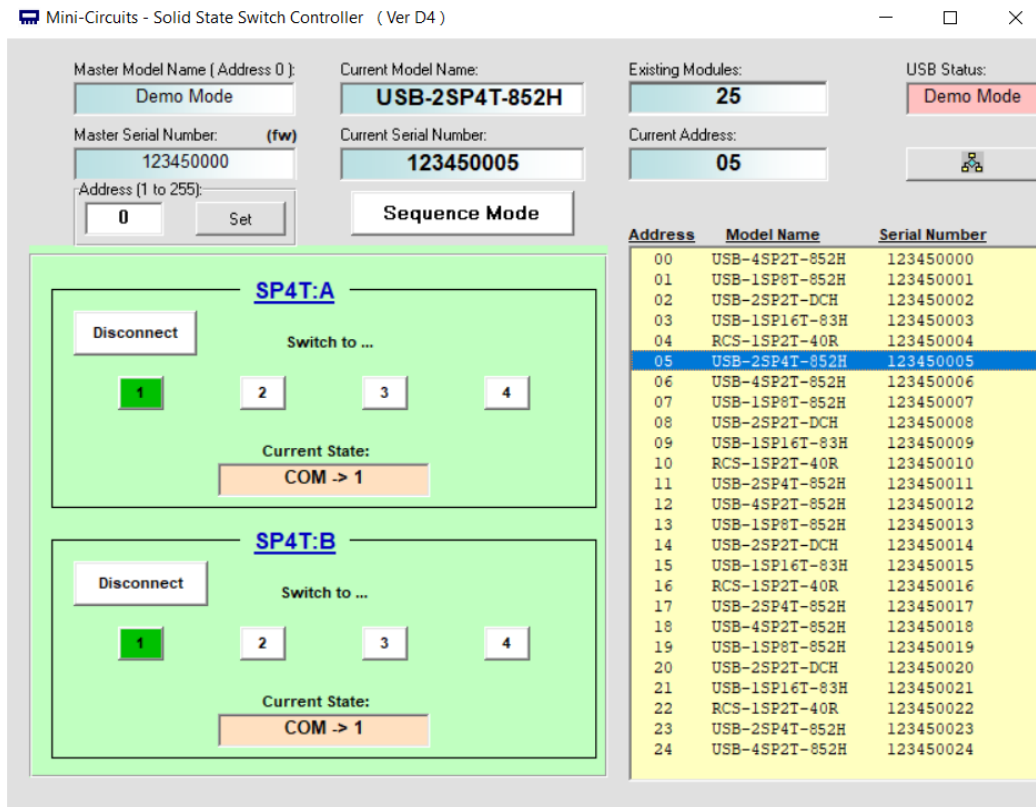



CONNECTING MULTIPLE MODULES (DAISY CHAIN)

The model is designed to connect up to 35 modules in series (daisy chain) using dynamic addressing, meaning there is no need to specifically set the address of the modules. The addresses will be set automatically as part of establishing the communications with the computer. The module connected to the computer's USB port will be assigned address 0 (master), the first module connected to it will get address 1 (slave) and subsequent modules incrementing up to address 34 (slave).

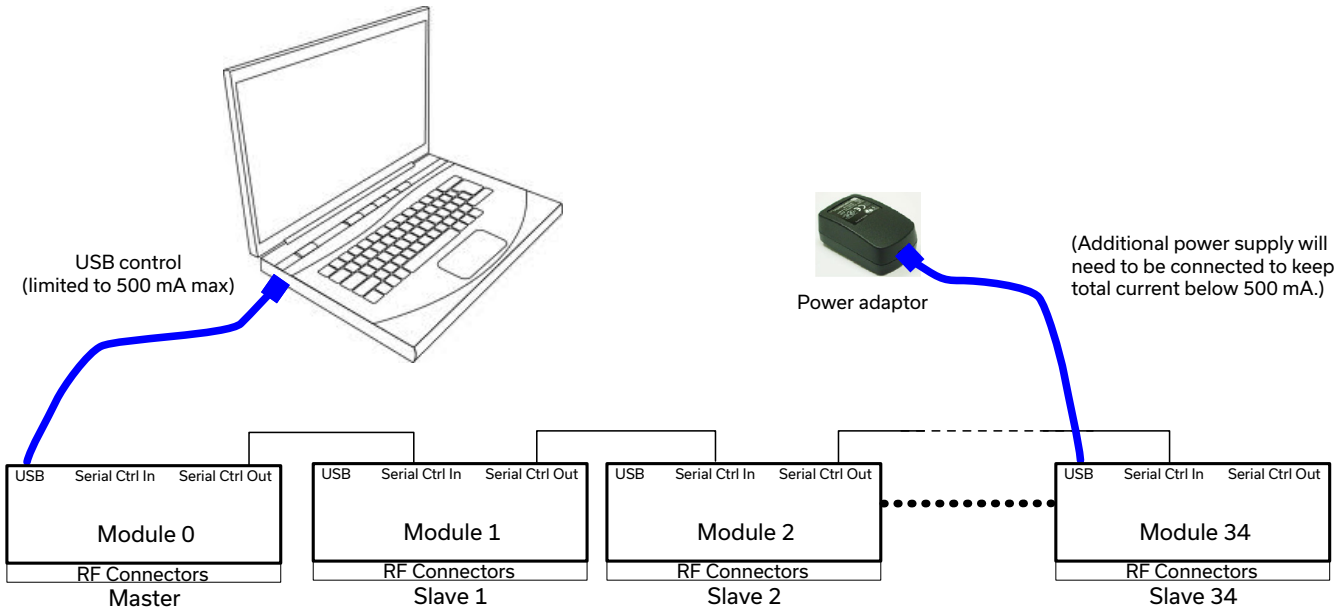

Connections between modules will be made using the serial in/out ports with the module connected to the PC act as a master and all other as slave modules. All control will be through the master module (address 0) which is the only one communicating with the PC. Serial control out port of each module should be connected to the serial control in port of the next module.

Power will be supplied from the PC via the master module up to a maximum of 500 mA. Generally, additional power supply will be needed to keep total current below 500 mA. All power supplies should be connected to the module via the module's USB port. Connecting an additional power supply will automatically cut off power draw from the serial control in port for that module.

The serial master/slave bus allows connecting modules of different types to the same daisy chain as long as all support Mini-Circuits Dynamic addressing setup. To add a new module to the setup, simply connect the module and refresh the address listing, no need to reset any of the existing modules or assign addresses manually.

Note: Different module types may have different current consumption which will change the number of units which can be connected before an additional power supply is needed.



BLOCK DIAGRAM

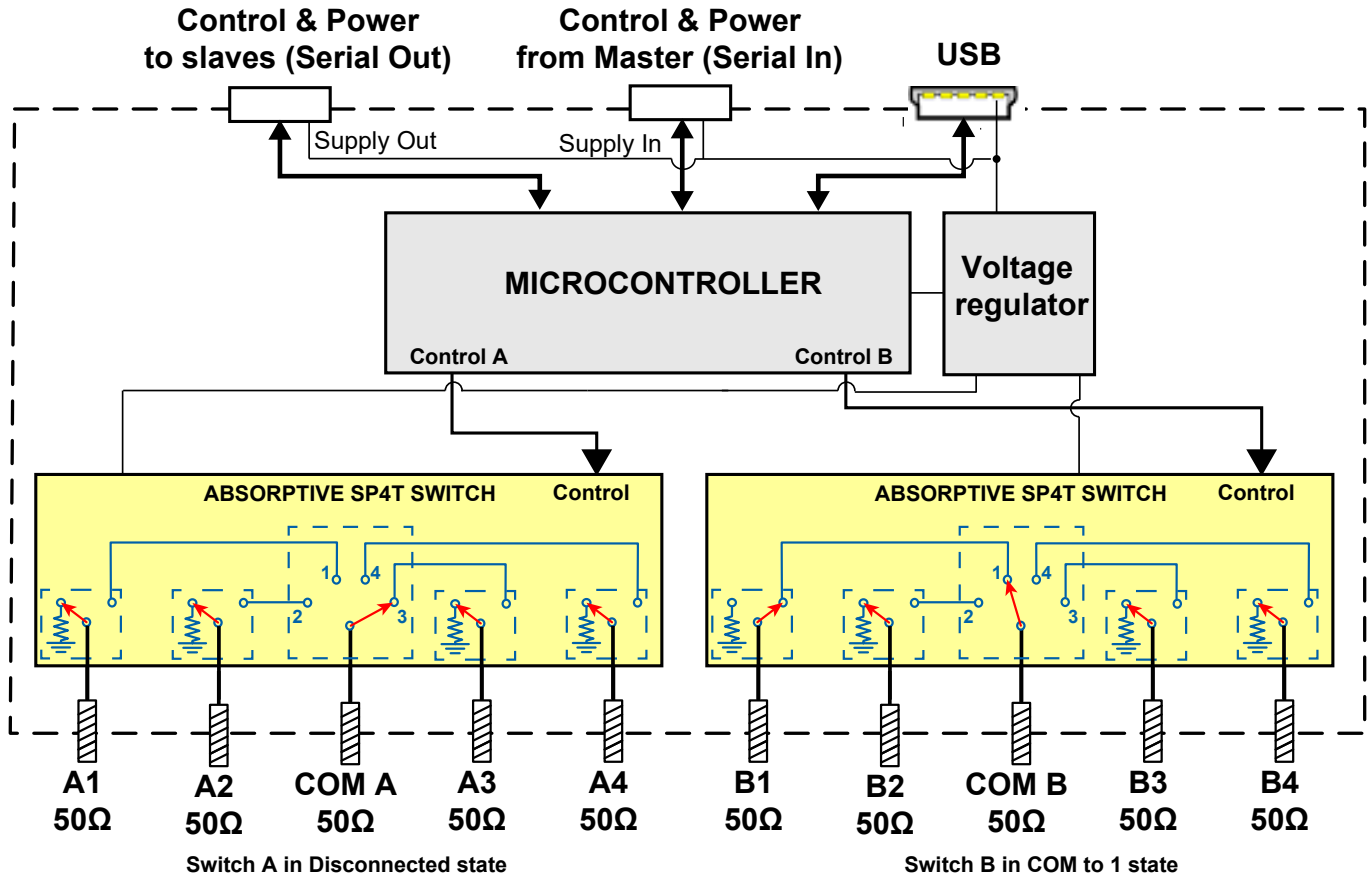

SWITCH STATE TABLE

State	Switch path
0	All ports disconnected
1	Com to 1
2	Com to 2
3	Com to 3
4	Com to 4

CONNECTIONS

Port name	Connector type
RF ports switch A (COM & 1 - 4)	SMA female
RF ports switch B (COM & 1 - 4)	SMA female
USB	USB type Mini-B receptacle
Serial in (digital control 2 port)	Digital snap fit connector ¹¹
Serial out (digital control 1 port)	Digital snap fit connector ¹¹

11. Mating connector is Hirose ST40X-10S-CV(30).



SP4T Switch

USB-2SP4T-852H

50Ω 10 to 8500 MHz

SMA female

CASE STYLE DRAWING (QM2605)

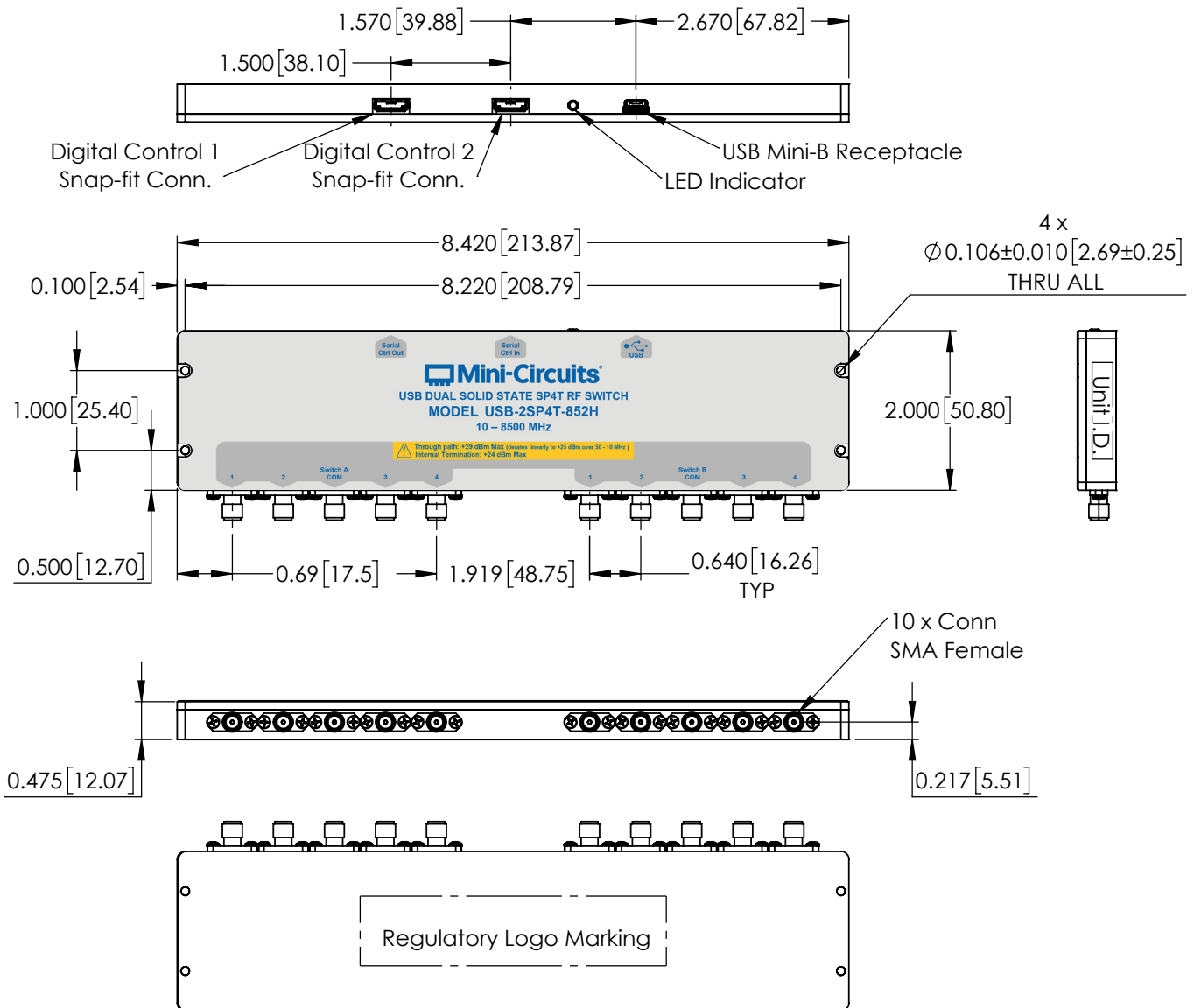

NOTES:

1. Case material: Aluminum alloy.
2. Case Finish: Nickel Plate.
3. Dimensions: Inches [mm]. Tolerances 2 Pl. ± 0.03 inch; 3 Pl. ± 0.015 inch.
4. Weight: 440 grams
5. Marking may contain other features or characters for internal lot control.



ADDITIONAL DETAILED MODEL INFORMATION IS AVAILABLE ON OUR WEBSITE

Ordering information	https://www.minicircuits.com/WebStore/dashboard.html?model=USB-2SP4T-852H
Performance data & graphs	https://www.minicircuits.com/pages/s-params/USB-2SP4T-852H_VIEW.pdf https://www.minicircuits.com/pages/s-params/USB-2SP4T-852H_GRAPHS.pdf
Case style	https://www.minicircuits.com/case_style/QM2605.pdf
Software, user guide & programming manual	https://www.minicircuits.com/softwaredownload/solidstate.html
Environmental rating	https://www.minicircuits.com/pcb/ENV55.pdf
Regulatory compliance	Refer to user guide for compliance information  https://www.minicircuits.com/app/AN49-012.pdf
Support	testsolutions@minicircuits.com

INCLUDED ACCESSORIES

Photo	Part No.	Description
	MUSB-CBL-3+	3.3 ft (1.0 m) USB Cable: USB type A (Male) to USB type Mini-B (Male)

OPTIONAL ACCESSORIES

Part No.	Description
MUSB-CBL-3+ (Spare)	3.3 ft (1.0 m) USB Cable: USB type A (Male) to USB type Mini-B (Male)
MUSB-CBL-7+	6.6 ft (2.0 m) USB Cable: USB type A (Male) to USB type Mini-B (Male)
CBL-1.5FT-MMD+	1.5 ft (0.5 m) cable assembly for serial control daisy chain with snap fit connectors
USB-AC/DC-5	AC/DC +5V power adaptor with USB connector ^{12, 13}

12. The power adaptor may be used to provide additional power via USB port when connecting several units in daisy chain control.

13. Includes power plugs for US, UK, EU, IL, AU & China. Plugs for other countries are also available. If you need a power cord for a country not listed please contact testsolutions@minicircuits.com

NOTES:

- Performance and quality attributes and conditions not expressly stated in this specification document are intended to be excluded and do not form a part of this specification document.
- Electrical specifications and performance data contained in this specification document are based on Mini-Circuit's applicable established test performance criteria and measurement instructions.
- The parts covered by this specification document are subject to Mini-Circuits standard limited warranty and terms and conditions (collectively, "Standard Terms"); Purchasers of this part are entitled to the rights and benefits contained therein. For a full statement of the Standard Terms and the exclusive rights and remedies thereunder, please visit Mini-Circuits' website at <https://www.minicircuits.com/terms/viewterm.html>