



MMIC SURFACE MOUNT

Low Noise Amplifier

TSY-83LN+

50Ω 0.4 to 8 GHz Bypass Mode Feature

THE BIG DEAL

- Low Loss Bypass Mode Feature
- Low Noise Figure, Typ. 1.5 dB
- High OIP3, Typ. +33.6 dBm
- High P1dB, Typ. +22.9 dBm
- 3x3 mm 12-Lead QFN-Style Package

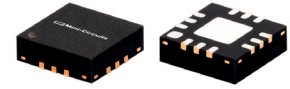

Generic photo used for illustration purposes only

APPLICATIONS

- Radar, EW, and ECM Defense Systems
- 5G Sub6, MIMO Wireless Infrastructure Systems
- Test & Measurement Equipment

FUNCTIONAL DIAGRAM

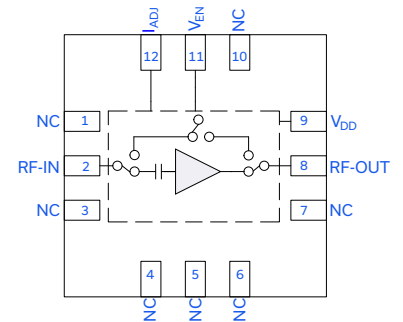

PRODUCT OVERVIEW

Mini-Circuits' TSY-83LN+ is a GaAs pHEMT based wide band, bypass mode capable, low noise MMIC amplifier with a combination of high IP3 and flat gain. Operating from 0.4 to 8 GHz, this amplifier features high dynamic range with 1.5 dB noise figure, 22 dB gain, +22.9 dBm P1dB, and +33.6 dBm OIP3. This combination of characteristics makes it ideal for sensitive, high dynamic range receiver applications where a gain stage may need to be quickly bypassed in the presence of high power RF signals. TSY-83LN+ operates on a single +5 V or +6 V supply, is well matched to 50Ω, and comes in a tiny, low profile 3x3 mm QFN-style package for ease of integration into dense circuit board layouts.

KEY FEATURES

Feature	Advantages
Bypass Mode Feature	Allows the user to quickly switch to a low loss bypass path while keeping the power supply at constant voltage to reduce gain and protect the system in the presence of high power RF signals.
Low Noise Figure, Typ. 1.5 dB at 2 GHz	Extremely low noise figure provides minimal signal-to-noise degradation in amplification mode.
High OIP3, Typ. +33.6 dBm at 2 GHz	The combination of low noise figure and high IP3 makes this MMIC amplifier ideal for use in sensitive low noise receiver front ends where high dynamic range is of paramount importance.
Wide Bandwidth with Flat Gain: ±0.6 dB over 0.4 to 6 GHz	Enables a single amplifier to be used across many applications including aerospace and defense (Radar, SATCOM, EW), broadband test instrumentation, telecommunications (5G Sub6), and more.
3x3 mm 12-Lead QFN-Style Package	Tiny footprint saves space in dense layouts while providing low inductance, repeatable transitions, and excellent thermal contact with the PCB. Industry standard packaging allows for ease of assembly in high volume manufacturing processes.

REV. A
ECO-021439
TSY-83LN+
MCL NY
240410





MMIC SURFACE MOUNT

Low Noise Amplifier

TSY-83LN+

50Ω 0.4 to 8 GHz Bypass Mode Feature

ELECTRICAL SPECIFICATIONS¹ AT +25°C, V_{DD} = +6 V, AND Z₀ = 50Ω UNLESS NOTED OTHERWISE

Parameter	Frequency (MHz)	Amplifier - ON			Amplifier - Bypass	Units
		Min.	Typ.	Max.	Typ.	
Frequency Range		400		8000	400-8000	MHz
Gain	400	21.0	21.8		-1.7	dB
	2000	21.4	22.3		-1.3	
	4000	21.2	22.3		-1.7	
	6000	22.1	23.0		-1.8	
	8000 ²	18.9	21.0		-3.5	
Input Return Loss	400		12.2		9.3	dB
	2000		16.4		14.4	
	4000		10.7		13.3	
	6000		16.3		10.3	
	8000 ²		7.4		5.8	
Output Return Loss	400		14.3		14.0	dB
	2000		20.0		15.3	
	4000		15.8		20.0	
	6000		20.0		10.9	
	8000 ²		16.9		5.5	
Isolation	400-8000		30.1			dB
Output Power at 1 dB Compression (P1dB)	400		+22.4		+10.5	dBm
	2000		+22.9		+11.9	
	4000		+22.5		+13.8	
	6000		+20.0		+13.9	
	8000 ²		+20.3		+14.1	
Output Third-Order Intercept Point (P _{OUT} = 0 dBm/Tone)	400		+32.2		+39.0	dBm
	2000		+33.6		+41.8	
	4000		+30.4		+41.6	
	6000		+26.2		+42.8	
	8000 ²		+25.0		+41.0	
Noise Figure	400		1.9			dB
	2000		1.5			
	4000		1.7			
	6000		1.7			
	8000 ²		2.5			
Device Operating Voltage (V _{DD})			+6		+6	V
Device Operating Current (I _{DD}) ³			104		4	mA
Enable Voltage (V _{EN}) ⁴			+6		0	V
Enable Current (I _{EN})			4.6		1.7	mA
Device Current Adjust (I _{ADJ}) ⁵			13		13	μA
Device Current Variation Vs. Temperature ⁶			-57		-57	μA/°C
Device Current Variation Vs. Voltage ⁷			0.028		0.028	mA/mV

1. Tested on Mini-Circuits Characterization Test Board TB-TSY-83LNC+. See Figure 2. Board loss de-embedded.

2. Tested on Mini-Circuits Characterization Test Board TB-TSY-832LNC+. See Figure 3. Board loss de-embedded.

3. Current at P_{IN} = -25 dBm. Increases to 150 mA at P1dB.4. V_{EN} must be equal to V_{DD} in Amplifier - ON mode.5. I_{ADJ} is not intended as a voltage input port. Gain is nominal when I_{ADJ} is left open. When I_{ADJ} is open, there is a measured voltage of +1.4 V on the pin. To change the current, add a shunt resistor (see Figures 2 and 3).

6. (Current at +105°C - Current at -45°C) / (+150°C)

7. (Current at +6 V - Current at +5 V) / (+6 V - +5 V)



**MMIC SURFACE MOUNT**

Low Noise Amplifier

TSY-83LN+**50Ω 0.4 to 8 GHz Bypass Mode Feature****ELECTRICAL SPECIFICATIONS⁸ AT +25°C, V_{DD} = +5 V, AND Z₀ = 50Ω UNLESS NOTED OTHERWISE**

Parameter	Frequency (MHz)	Amplifier - ON			Amplifier - Bypass Typ.	Units
		Min.	Typ.	Max.		
Frequency Range		400		8000	400-8000	MHz
Gain	400	20.0	21.2		-1.6	dB
	2000	20.8	21.8		-1.3	
	4000	20.5	21.6		-1.6	
	6000	21.6	22.3		-1.8	
	8000 ⁹	18.5	20.6		-3.5	
Input Return Loss	400		11.5		9.3	dB
	2000		15.2		14.4	
	4000		10.0		13.5	
	6000		15.2		10.3	
	8000 ⁹		7.4		5.8	
Output Return Loss	400		14.7		13.8	dB
	2000		20.0		15.3	
	4000		14.3		20.0	
	6000		18.5		10.9	
	8000 ⁹		16.8		5.5	
Isolation	400-8000		29.7			dB
Output Power at 1 dB Compression (P1dB)	400		+20.5		+10.9	dBm
	2000		+21.2		+12.2	
	4000		+20.5		+14.3	
	6000		+18.4		+14.4	
	8000 ⁹		+18.8		+14.9	
Output Third-Order Intercept Point (P _{OUT} = 0 dBm/Tone)	400		+31.4		+41.1	dBm
	2000		+31.5		+43.5	
	4000		+28.4		+42.5	
	6000		+24.3		+44.6	
	8000 ⁹		+24.6		+41.7	
Noise Figure	400		1.8			dB
	2000		1.5			
	4000		1.6			
	6000		1.7			
	8000 ⁹		2.4			
Device Operating Voltage (V _{DD})			+5		+5	V
Device Operating Current (I _{DD}) ¹⁰			76		3	mA
Enable Voltage (V _{EN}) ¹¹			+5		0	V
Enable Current (I _{EN})			4.5		1.7	mA
Device Current Adjust (I _{ADJ}) ¹²			13		13	μA
Device Current Variation Vs. Temperature ¹³			-37		-37	μA/°C
Device Current Variation Vs. Voltage ¹⁴			0.028		0.028	mA/mV

8. Tested on Mini-Circuits Characterization Test Board TB-TSY-83LNC+. See Figure 2. Board loss de-embedded.

9. Tested on Mini-Circuits Characterization Test Board TB-TSY-832LNC+. See Figure 3. Board loss de-embedded.

10. Current at P_{IN} = -25 dBm. Increases to 140 mA at P1dB.11. V_{EN} must be equal to V_{DD} in Amplifier - ON mode.12. I_{ADJ} is not intended as a voltage input port. Gain is nominal when I_{ADJ} is left open. When I_{ADJ} is open, there is a measured voltage of +1.4 V on the pin. To change the current, add a shunt resistor (see Figures 2 and 3).

13. (Current at +105°C - Current at -45°C) / (+150°C)

14. (Current at +6 V - Current at +5 V) / (+6 V - +5 V)

SWITCHING SPECIFICATIONS¹⁵

Parameter	+6 V Typ.	+5 V Typ.	Units
Amplifier ON to Bypass	OFF Time (50% Control to 10% RF)	16	17 ns
	FALL Time (90% to 10% RF)	17	17 ns
Amplifier Bypass to ON	ON Time (50% Control to 90% RF)	168	168 ns
	RISE Time (10% to 90% RF)	112	112 ns
Control Voltage Leakage	+97	+83	mV

15. Tested on Mini-Circuits Characterization Test Board TB-TSY-83LNC+. See Figure 2.





TYPICAL PERFORMANCE GRAPHS IN AMPLIFIER-ON MODE

Note: The following data was taken on the Mini-Circuits Characterization Test Board TB-TSY-83LNC+ (Figure 2). All data taken at nominal conditions $V_{EN} = V_{DD}$ and $RI_{ADJ} = \text{Open}$ unless noted otherwise.

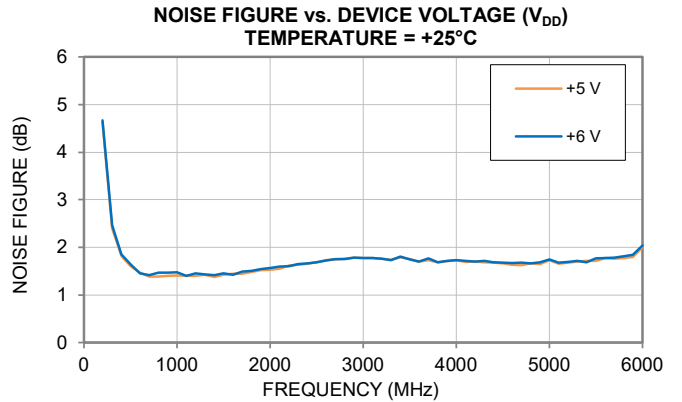
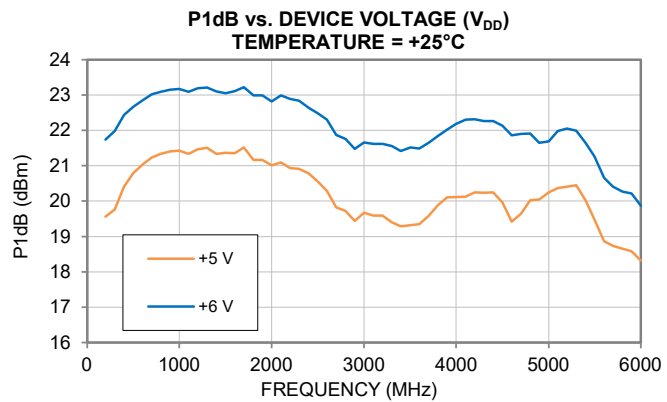
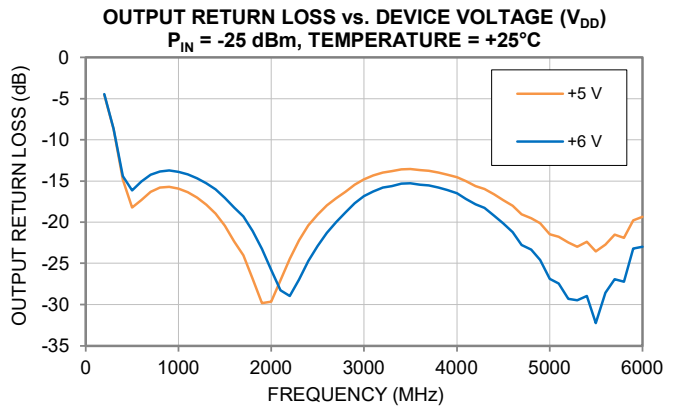
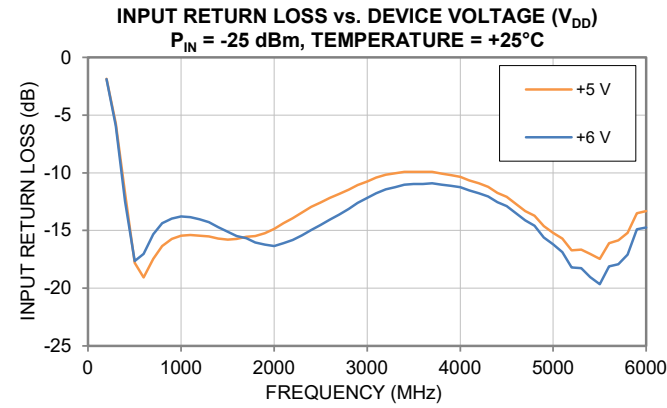
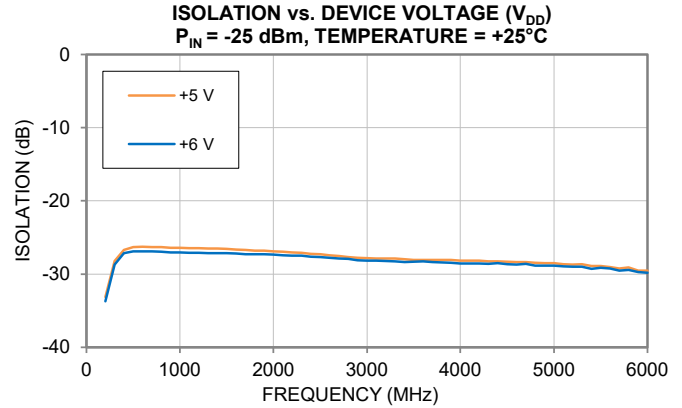
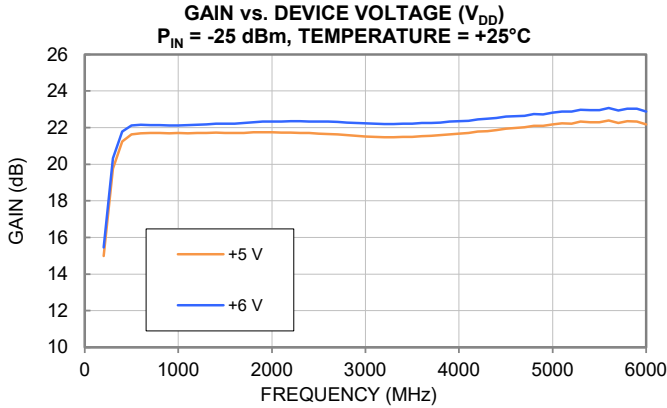



TYPICAL PERFORMANCE GRAPHS IN AMPLIFIER-ON MODE

Note: The following data was taken on the Mini-Circuits Characterization Test Board TB-TSY-83LNC+ (Figure 2). All data taken at nominal conditions $V_{EN} = V_{DD}$ and $RI_{ADJ} = \text{Open}$ unless noted otherwise.

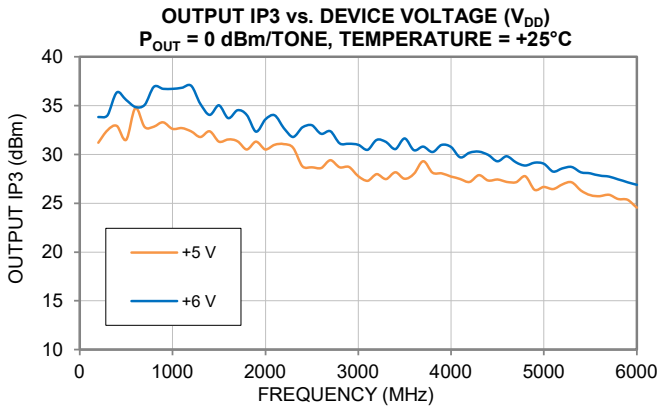
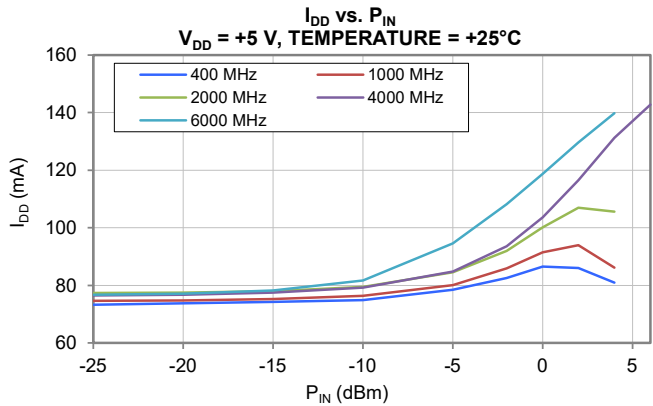
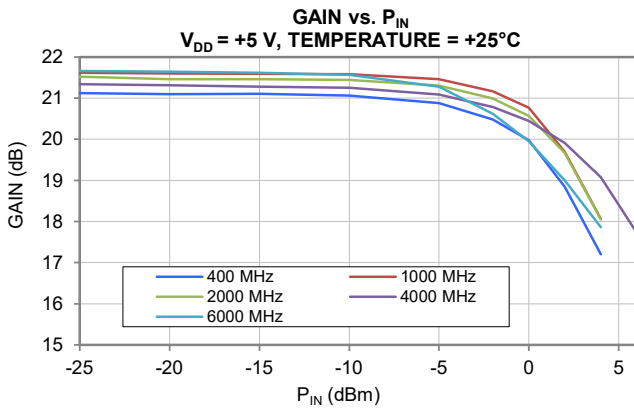
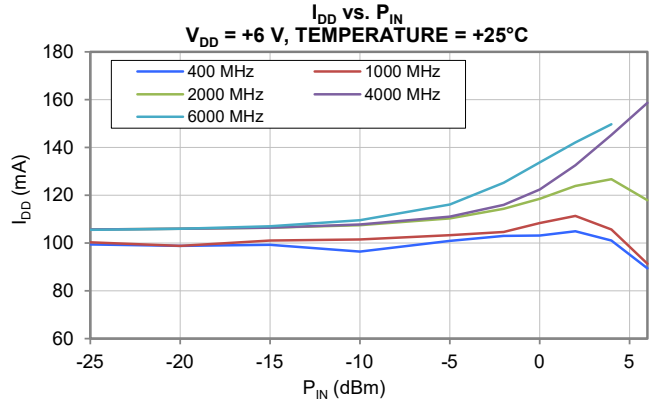
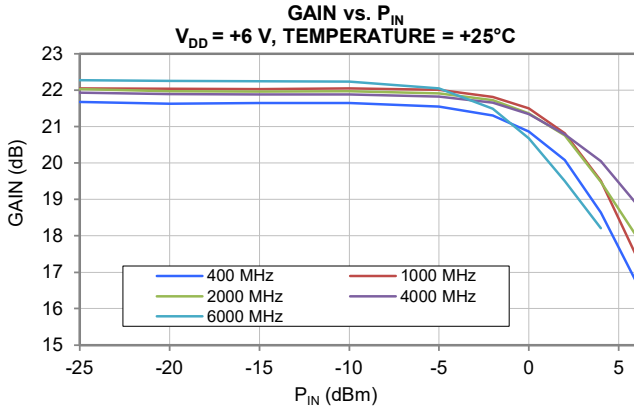



TYPICAL PERFORMANCE GRAPHS IN AMPLIFIER-ON MODE

Note: The following data was taken on the Mini-Circuits Characterization Test Board TB-TSY-832LNC+ (Figure 3). All data taken at nominal conditions $V_{EN} = V_{DD}$ and $RI_{ADJ} = \text{Open}$ unless noted otherwise.

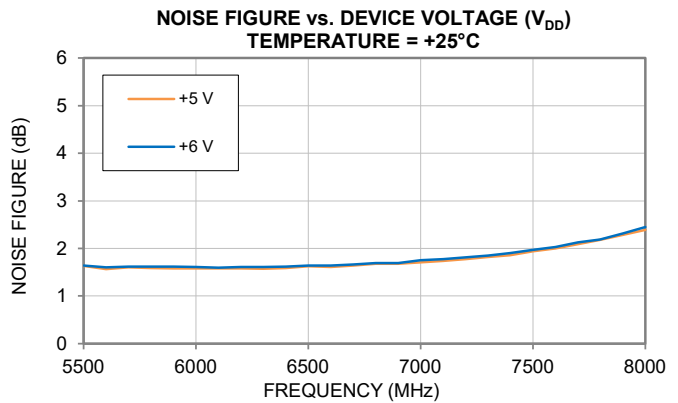
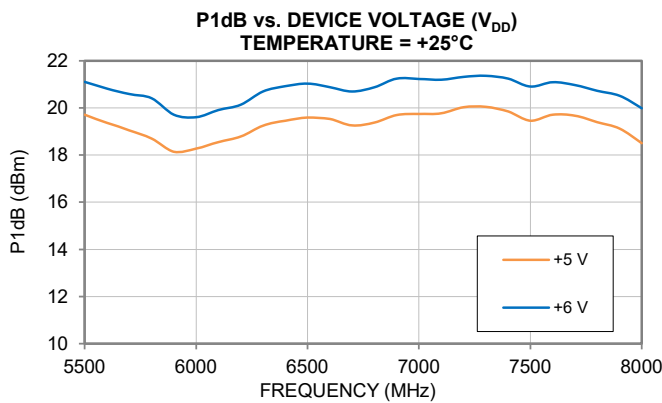
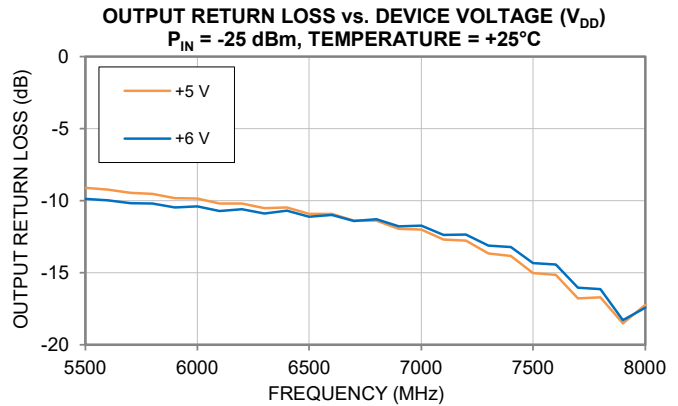
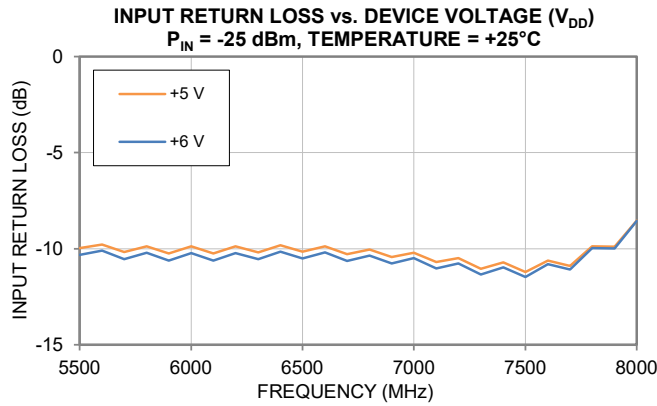
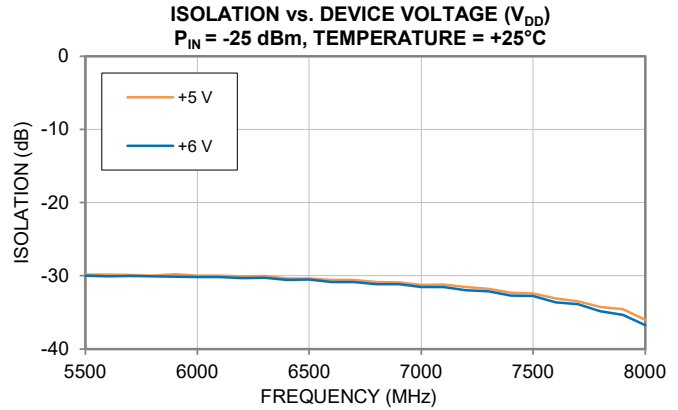
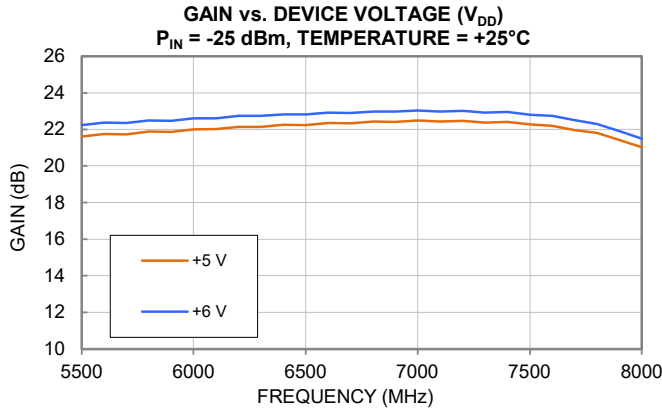



TYPICAL PERFORMANCE GRAPHS IN AMPLIFIER-ON MODE

Note: The following data was taken on the Mini-Circuits Characterization Test Board TB-TSY-832LNC+ (Figure 3). All data taken at nominal conditions $V_{EN} = V_{DD}$ and $RI_{ADJ} = \text{Open}$ unless noted otherwise.

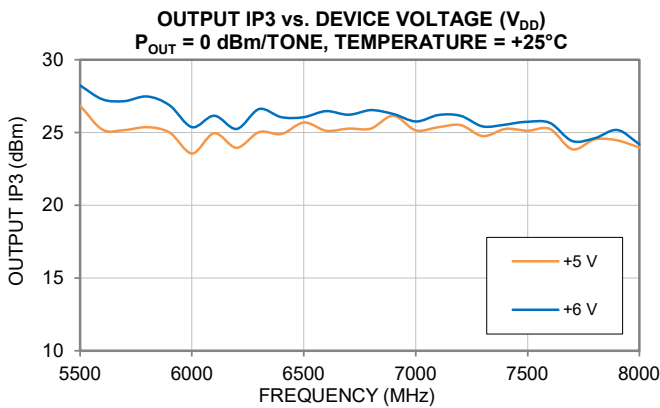
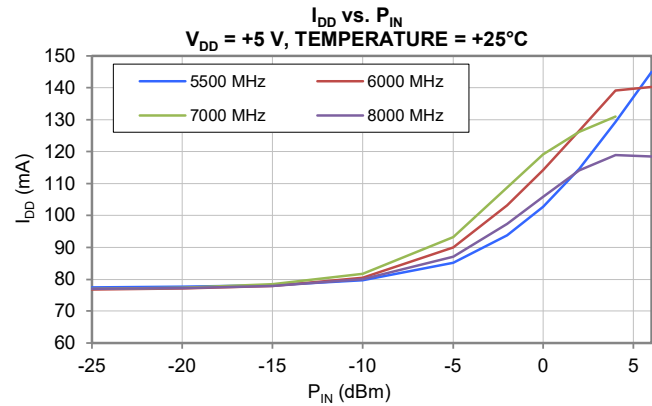
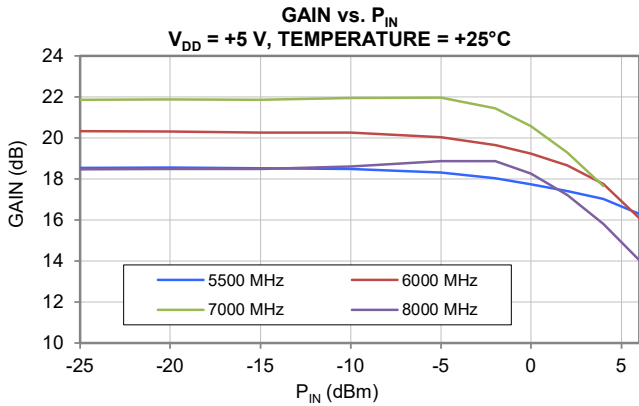
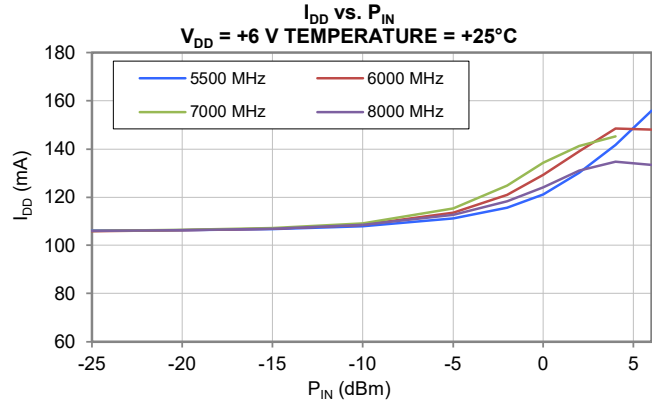
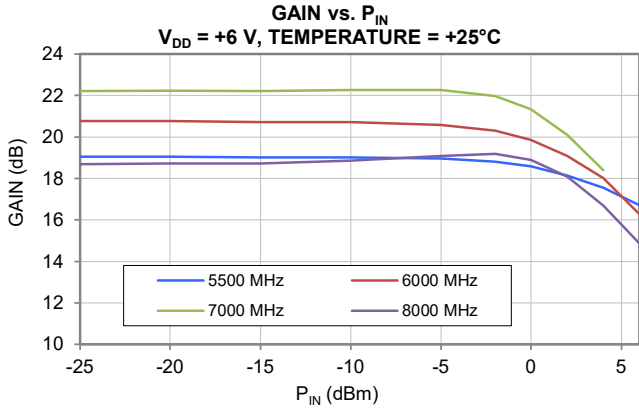



TYPICAL PERFORMANCE GRAPHS IN AMPLIFIER-ON MODE

Note: The following data was taken on the Mini-Circuits Characterization Test Board TB-TSY-83LNC+ (Figure 2). All data taken at nominal conditions $V_{EN} = V_{DD} = +6 V$ unless noted otherwise.

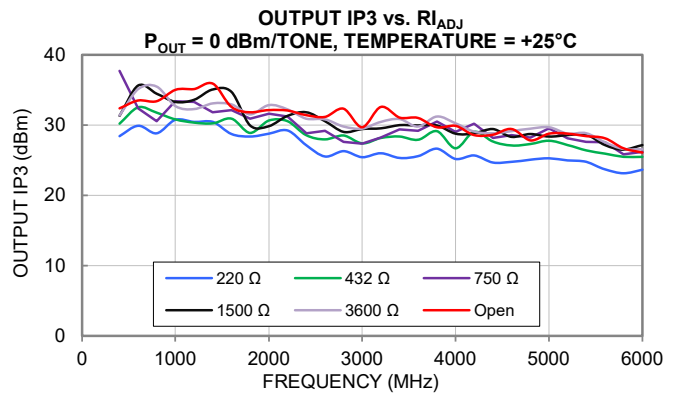
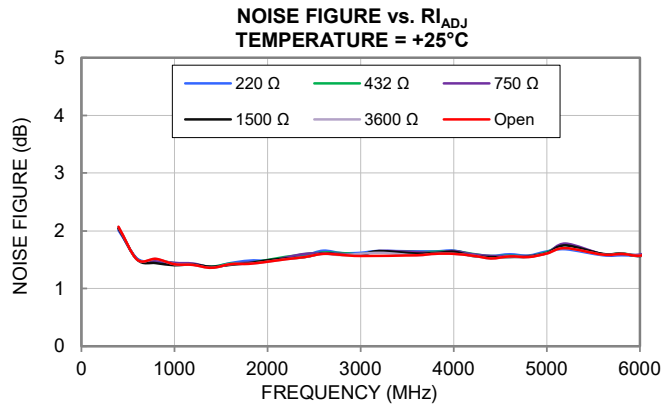
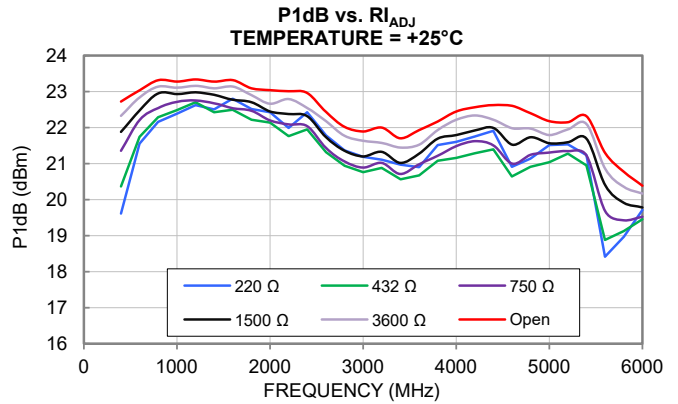
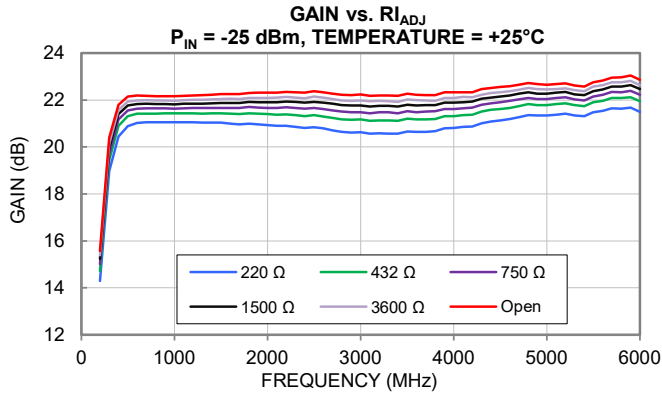



TYPICAL PERFORMANCE GRAPHS IN AMPLIFIER-ON MODE

Note: The following data was taken on the Mini-Circuits Characterization Test Board TB-TSY-832LNC+ (Figure 3). All data taken at nominal conditions $V_{EN} = V_{DD} = +6\text{ V}$ unless noted otherwise.

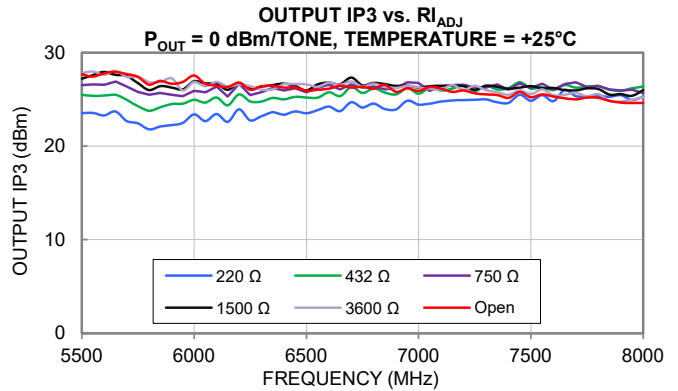
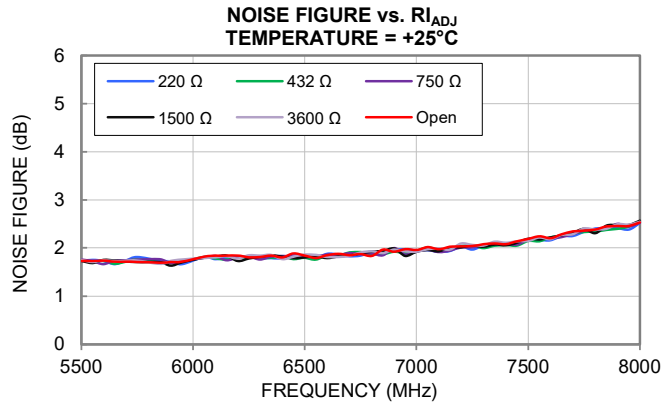
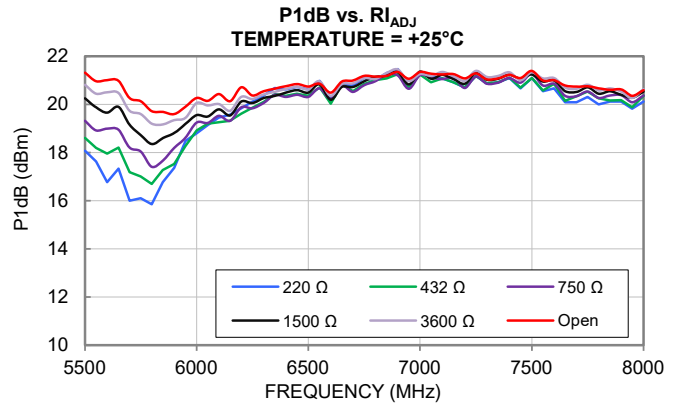
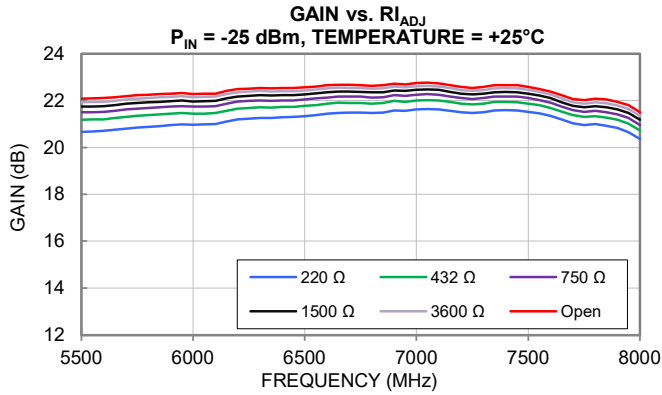



TYPICAL PERFORMANCE GRAPHS IN BYPASS MODE

Note: The following data was taken on the Mini-Circuits Characterization Test Board TB-TSY-83LNC+ (Figure 2). All data taken at nominal conditions $V_{EN} = 0$ V and $RI_{ADJ} = \text{Open}$ unless noted otherwise.

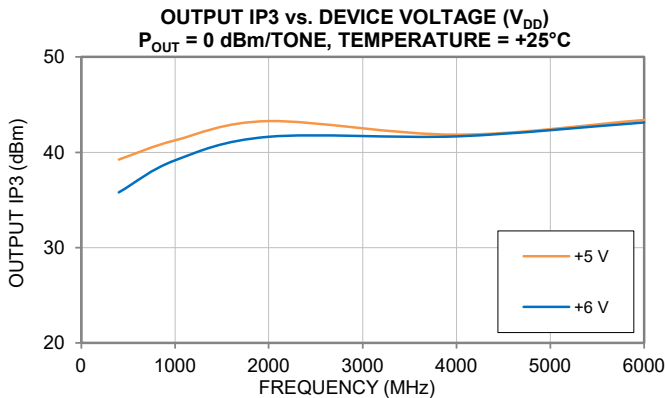
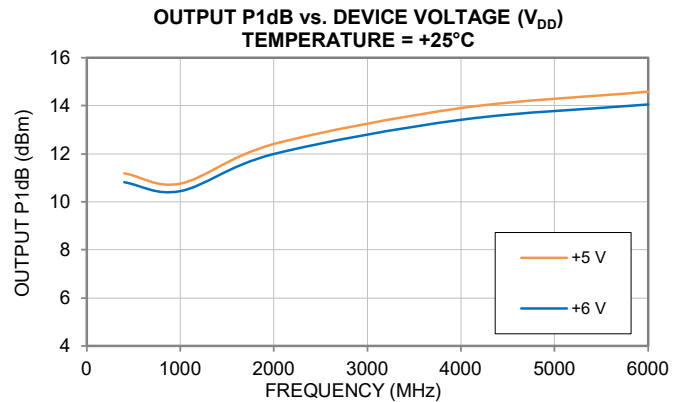
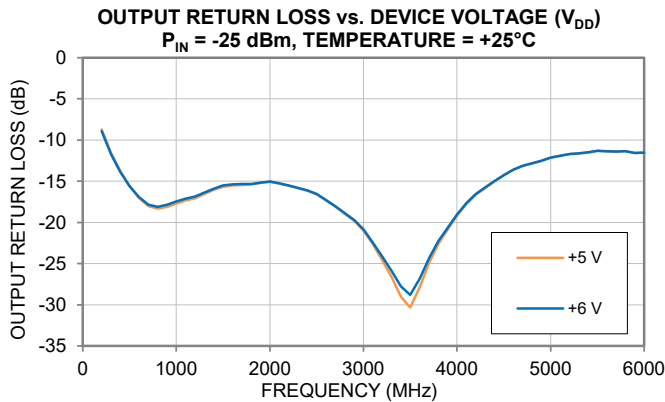
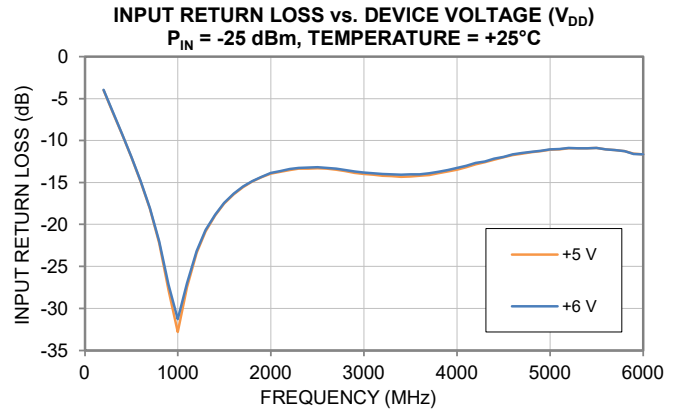
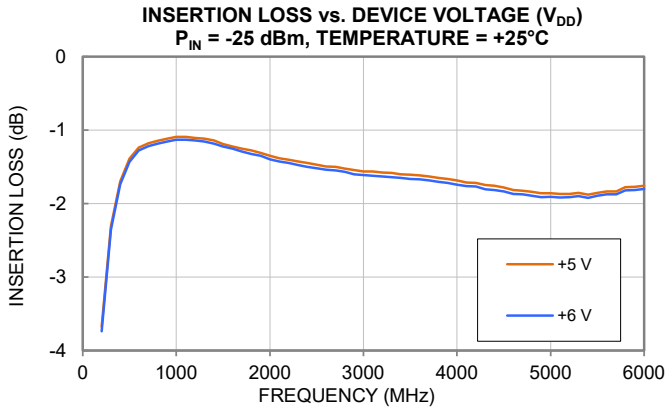



TYPICAL PERFORMANCE GRAPHS IN BYPASS MODE

Note: The following data was taken on the Mini-Circuits Characterization Test Board TB-TSY-832LNC+ (Figure 3). All data taken at nominal conditions $V_{EN} = 0$ V and $RI_{ADJ} = \text{Open}$ unless noted otherwise.

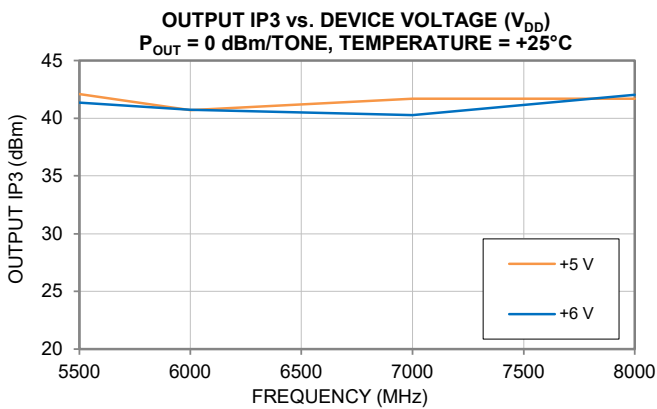
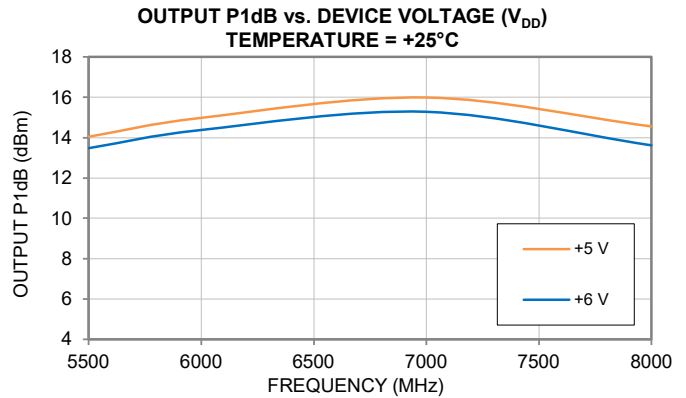
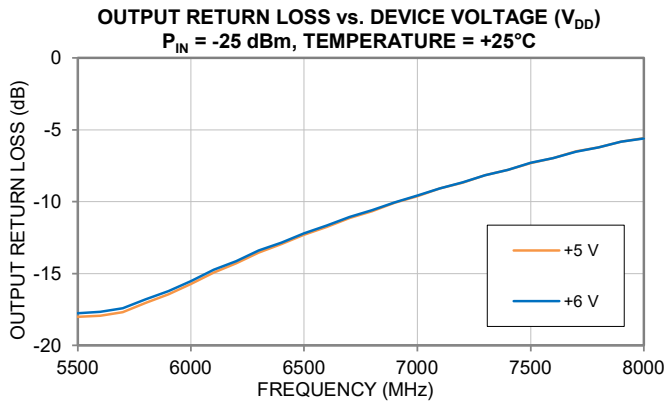
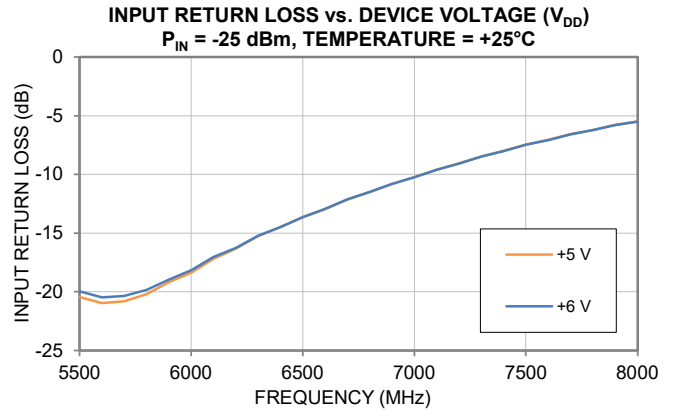
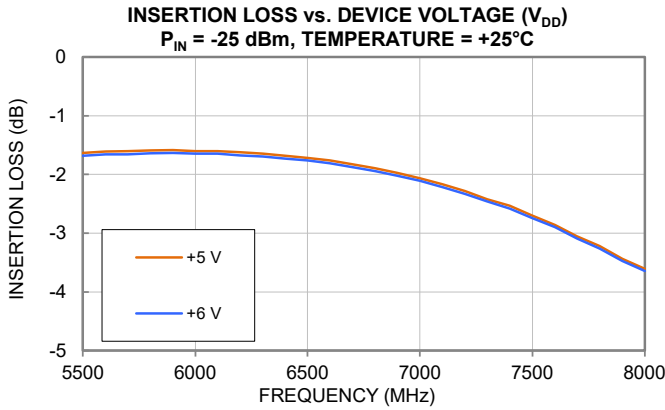



MMIC SURFACE MOUNT

Low Noise Amplifier

TSY-83LN+

50Ω 0.4 to 8 GHz Bypass Mode Feature

TYPICAL PERFORMANCE GRAPHS IN AMPLIFIER-ON MODE

Note: The following data was taken on the Mini-Circuits Characterization Test Board TB-TSY-83LNC+ (Figure 2). All data taken at nominal conditions $V_{EN} = V_{DD} = +6 V$, and $RI_{ADJ} = \text{Open}$ unless noted otherwise.

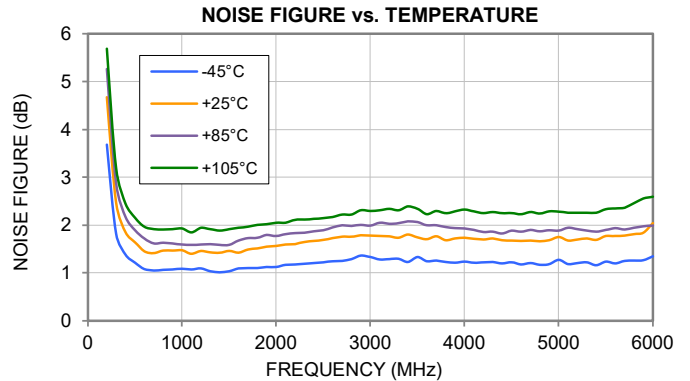
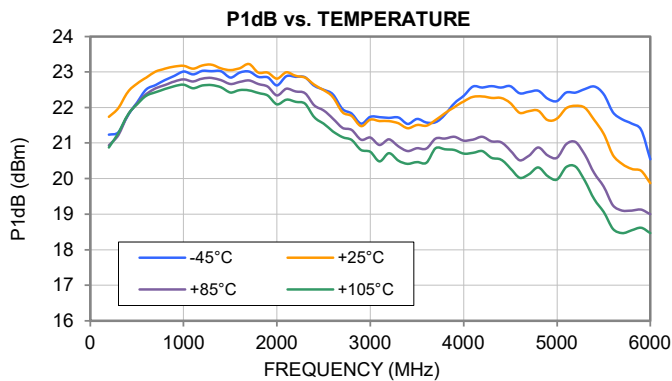
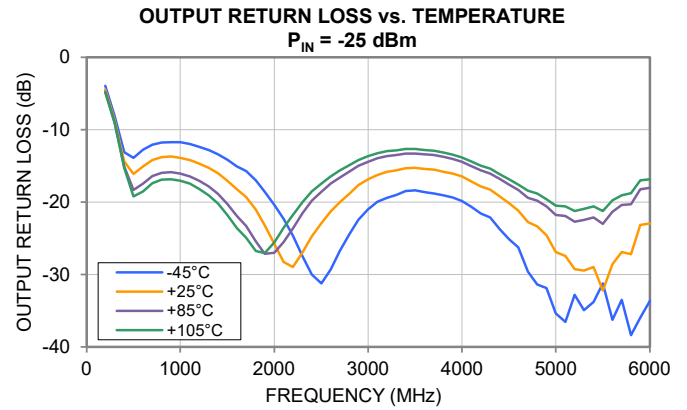
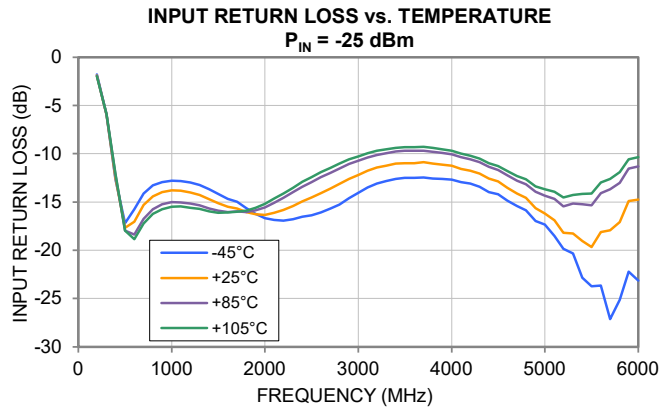
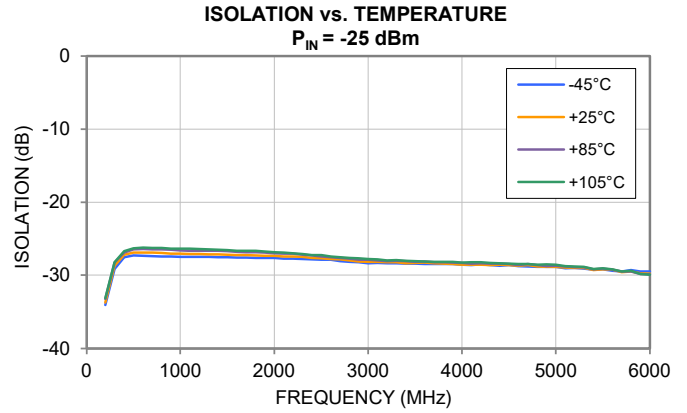
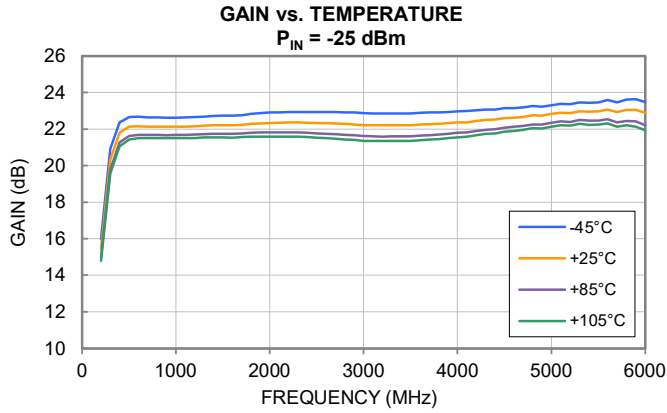



TYPICAL PERFORMANCE GRAPHS IN AMPLIFIER-ON MODE

Note: The following data was taken on the Mini-Circuits Characterization Test Board TB-TSY-83LNC+ (Figure 2). All data taken at nominal conditions $V_{EN} = V_{DD} = +6 V$, and $RI_{ADJ} = \text{Open}$ unless noted otherwise.

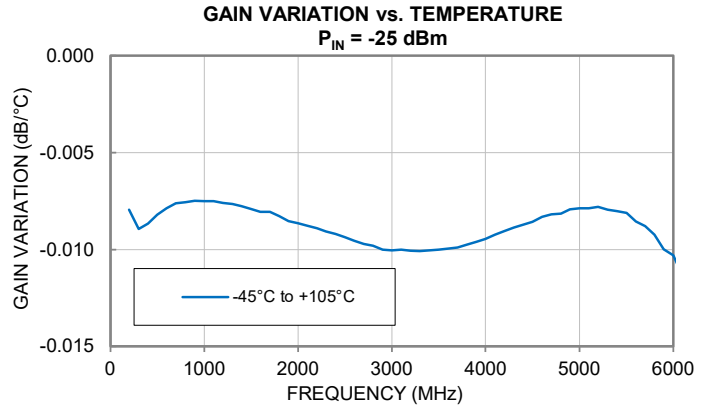
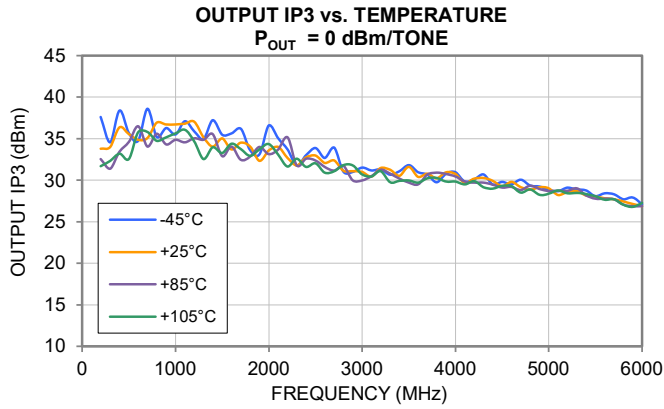



MMIC SURFACE MOUNT

Low Noise Amplifier

TSY-83LN+

50Ω 0.4 to 8 GHz Bypass Mode Feature

TYPICAL PERFORMANCE GRAPHS IN AMPLIFIER-ON MODE

Note: The following data was taken on the Mini-Circuits Characterization Test Board TB-TSY-832LNC+ (Figure 3). All data taken at nominal conditions $V_{EN} = V_{DD} = +6$ V and $RI_{ADJ} = \text{Open}$ unless noted otherwise.

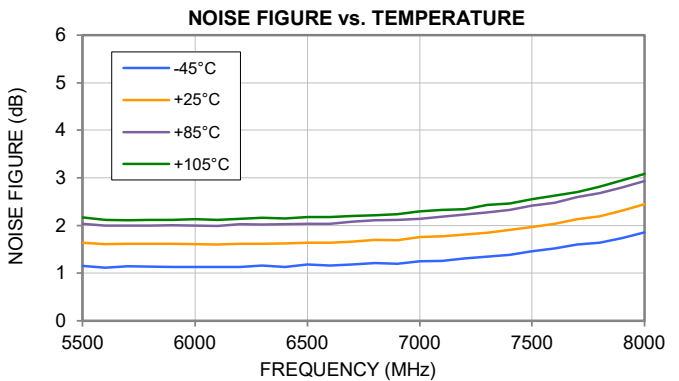
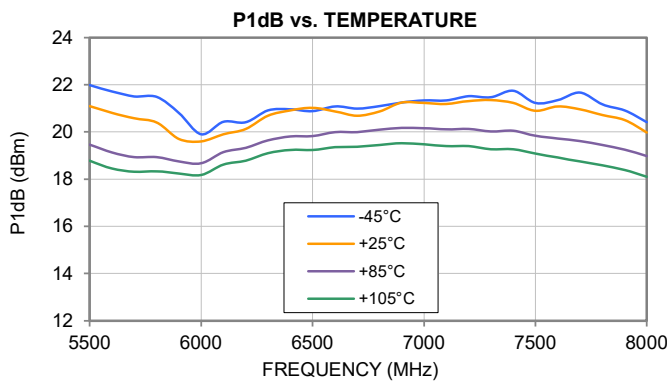
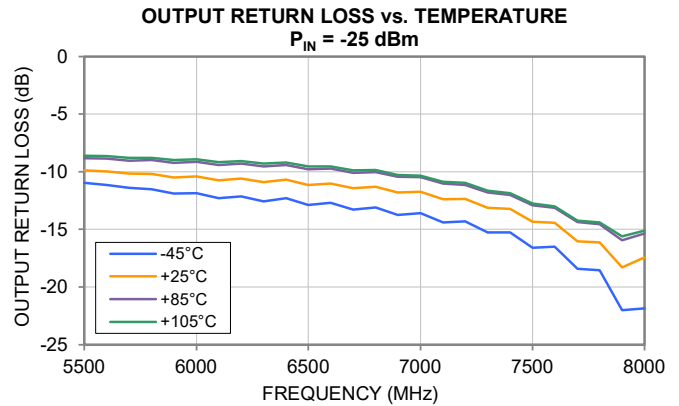
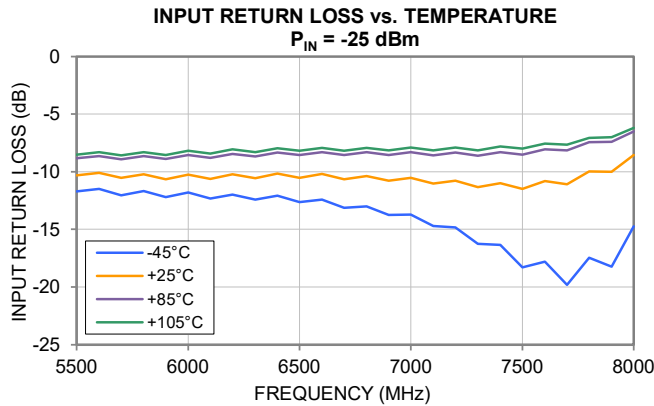
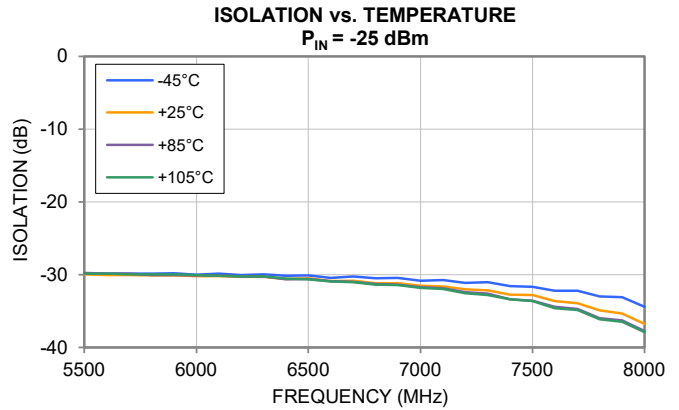
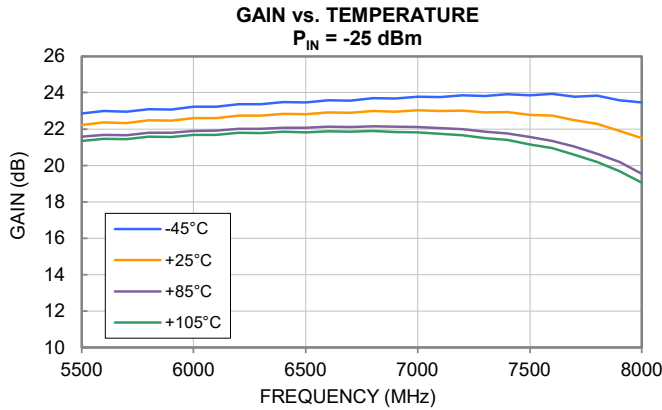



MMIC SURFACE MOUNT

Low Noise Amplifier

TSY-83LN+

50Ω 0.4 to 8 GHz Bypass Mode Feature

TYPICAL PERFORMANCE GRAPHS IN AMPLIFIER-ON MODE

Note: The following data was taken on the Mini-Circuits Characterization Test Board TB-TSY-832LNC+ (Figure 3). All data taken at nominal conditions $V_{EN} = V_{DD} = +6$ V and $RI_{ADJ} = \text{Open}$ unless noted otherwise.

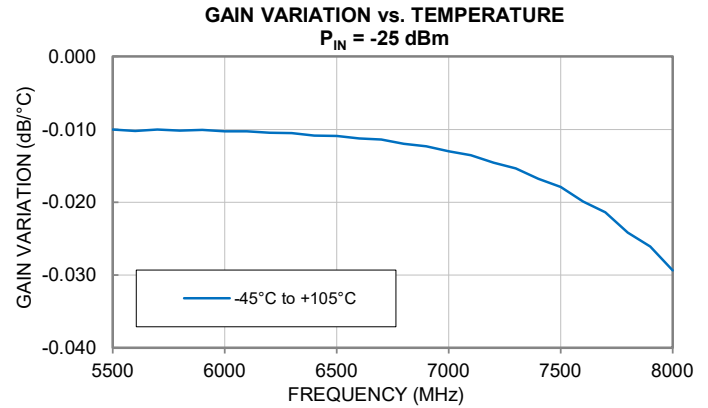
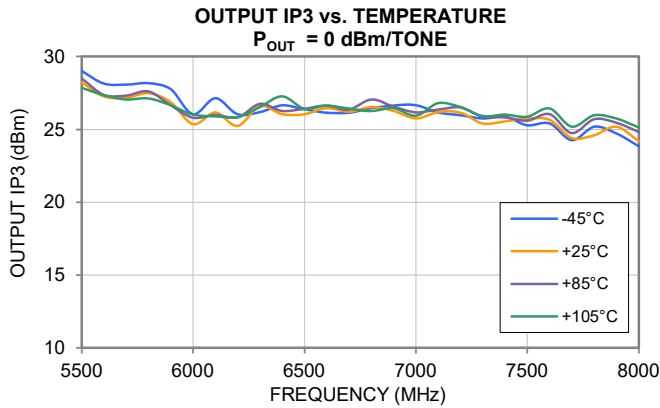



TYPICAL PERFORMANCE GRAPHS IN BYPASS MODE

Note: The following data was taken on the Mini-Circuits Characterization Test Board TB-TSY-83LNC+ (Figure 2). All data taken at nominal conditions $V_{EN} = 0$ V, $V_{DD} = +6$ V, and $R_{ADJ} = \text{Open}$ unless noted otherwise.

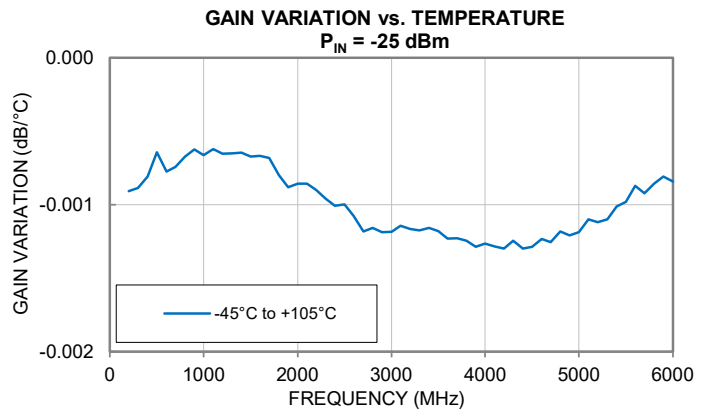
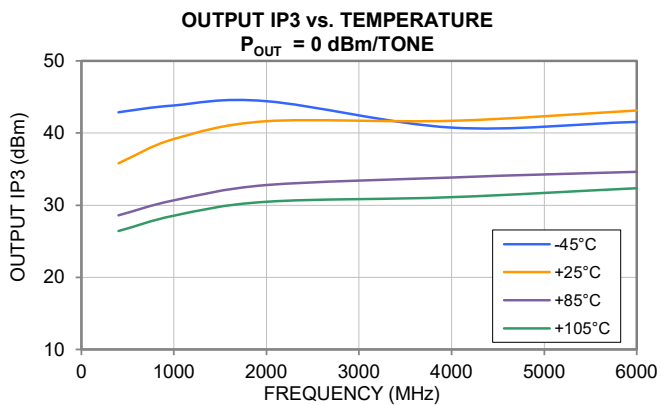
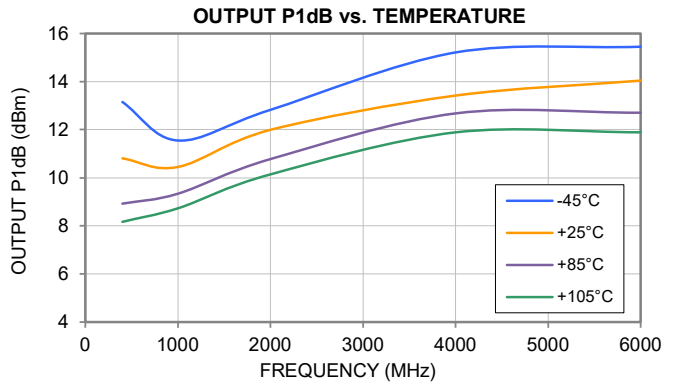
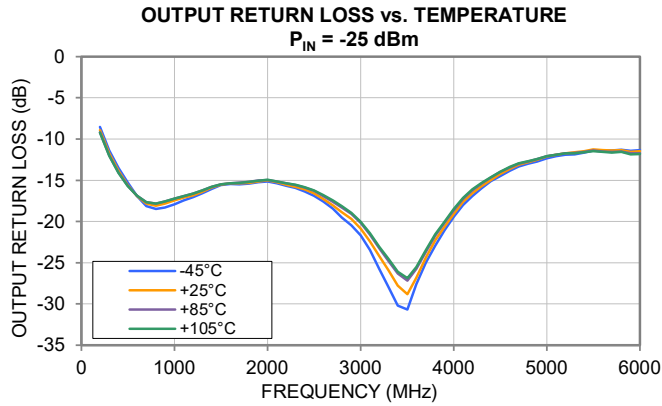
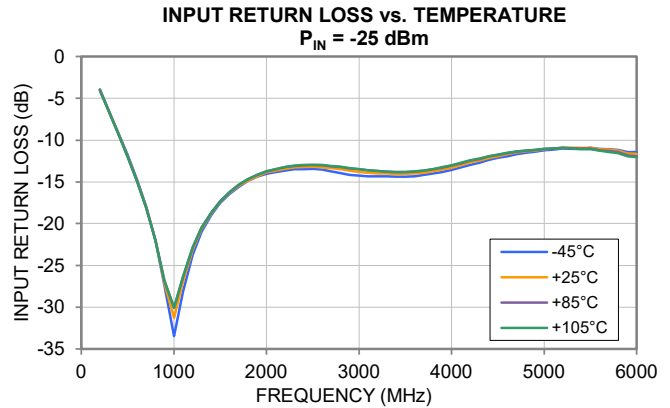
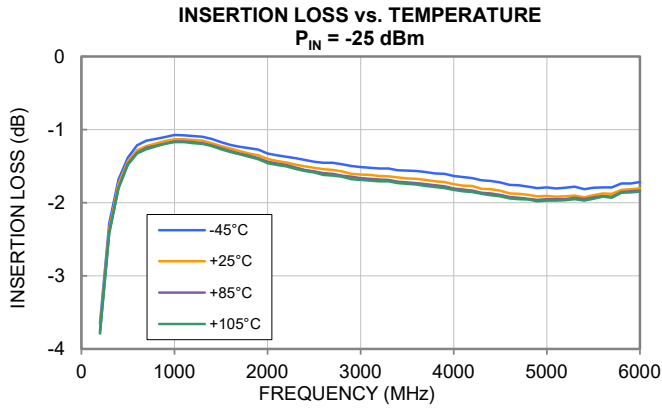



TYPICAL PERFORMANCE GRAPHS IN BYPASS MODE

Note: The following data was taken on the Mini-Circuits Characterization Test Board TB-TSY-832LNC+ (Figure 3). All data taken at nominal conditions $V_{EN} = 0\text{ V}$, $V_{DD} = +6\text{ V}$, and $R_{ADJ} = \text{Open}$ unless noted otherwise.

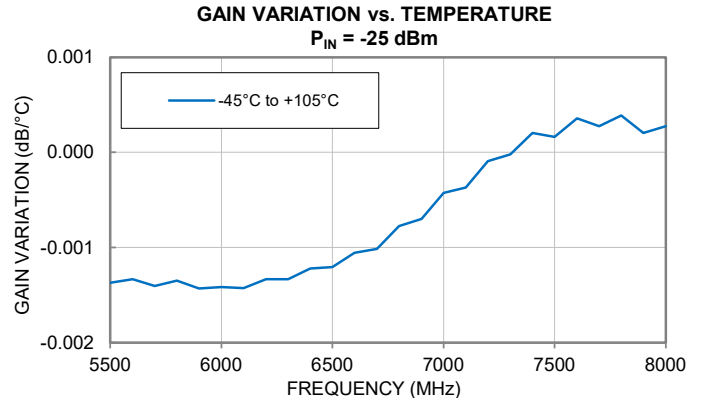
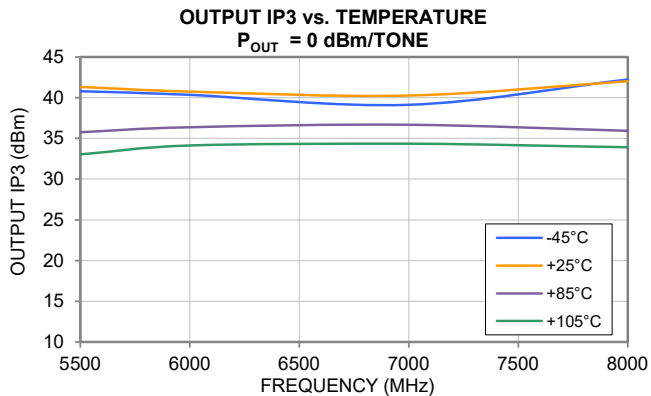
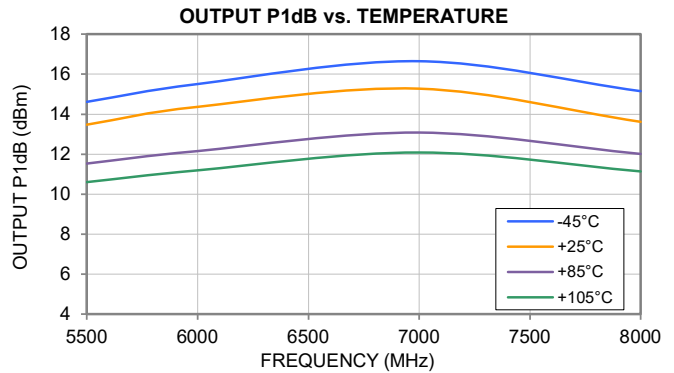
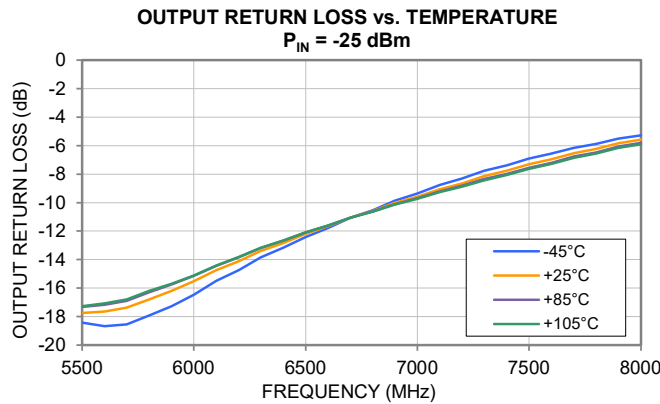
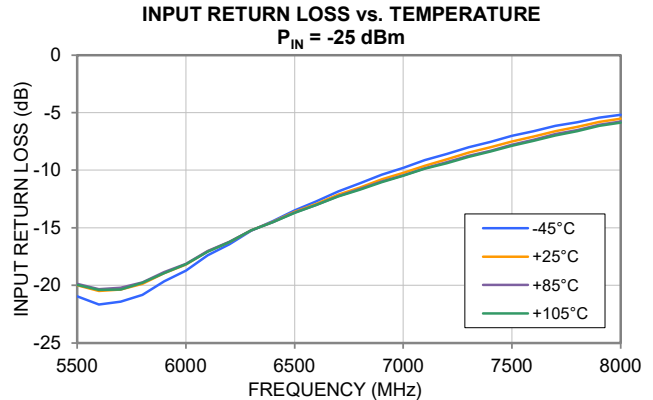
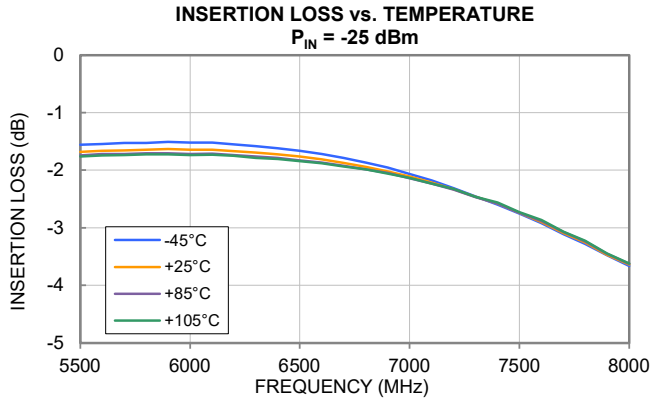



MMIC SURFACE MOUNT

Low Noise Amplifier

TSY-83LN+

50Ω 0.4 to 8 GHz Bypass Mode Feature

ABSOLUTE MAXIMUM RATINGS¹⁶

Parameter	Ratings	
Operating Temperature	-45°C to +105°C	
Storage Temperature	-65°C to +150°C	
Total Power Dissipation	0.83 W	
Junction Temperature ¹⁷	+150°C	
Input Power (CW)	Amplifier - ON	+22 dBm
	Amplifier - Bypass	+29 dBm
DC Voltage on RF-OUT	+14.5 V	
DC Voltage on RF-IN	+22 V	
DC Voltage on V _{DD}	+9 V	
Current I _{DD}	180 mA	
DC Voltage on V _{EN}	+9 V	
Current I _{EN}	60 mA	
Current I _{ADJ}	10 mA	

16. Permanent damage may occur if any of these are exceeded. Maximum ratings are not intended for continuous normal operations.

17. Peak temperature at top of Die

THERMAL RESISTANCE

Parameter	Ratings
Thermal Resistance (θ_{JC}) ¹⁸	54.3°C/W

18. θ_{JC} = (Hot Spot Temperature on Die - Temperature at Ground Lead)/Dissipated Power

ESD RATING

	Class	Voltage Range	Reference Standard
HBM	1A	250 V to < 500 V	ANSI/ESDA/JEDEC JS-001-2017
CDM	C3	≥ 1000 V	JESD22-C101F



ESD HANDLING PRECAUTION: This device is designed to be Class 1A for HBM. Static charges may easily produce potentials higher than this with improper handling and can discharge into DUT and damage it. As a preventive measure Industry standard ESD handling precautions should be used at all times to protect the device from ESD damage.

MSL RATING

Moisture Sensitivity: MSL1 in accordance with IPC/JEDEC J-STD-020E/JEDEC J-STD-033C





MMIC SURFACE MOUNT

Low Noise Amplifier

TSY-83LN+

50Ω 0.4 to 8 GHz Bypass Mode Feature

FUNCTIONAL DIAGRAM

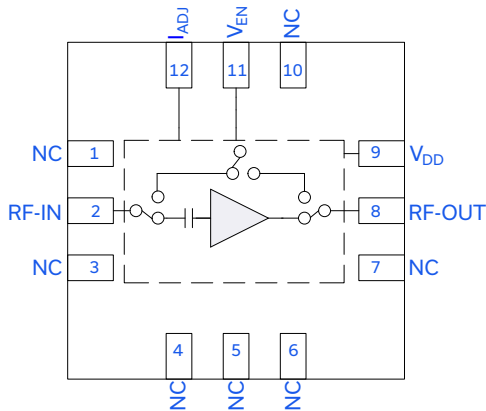

Figure 1. TSY-83LN+ Functional Diagram. Amplifier shown in ON mode.

PAD DESCRIPTION

Function	Pad Number	Description (Refer to Figure 1)
RF-IN	2	RF-IN Pad connects to RF-Input port.
RF-OUT	8	RF-OUT Pad connects to RF-Output port.
V _{DD}	9	DC Input Pad connects to device voltage input port.
V _{EN}	11	DC Input Pad connects to enable voltage input port.
I _{ADJ} ¹⁹	12	Current Adjustment Pad connects to port, I _{ADJ} . Port left open for nominal operation. I _{ADJ} can be adjusted with the use of an external resistor (see Figures 2 and 3).
GND	Paddle, Index	Connects to ground.
NC	1, 3-7, 10	Not used internally. Connected to ground on test board.

19. I_{ADJ} port not intended as a voltage input port. Permanent damage can occur with a voltage applied to this port.

CHARACTERIZATION BOARD

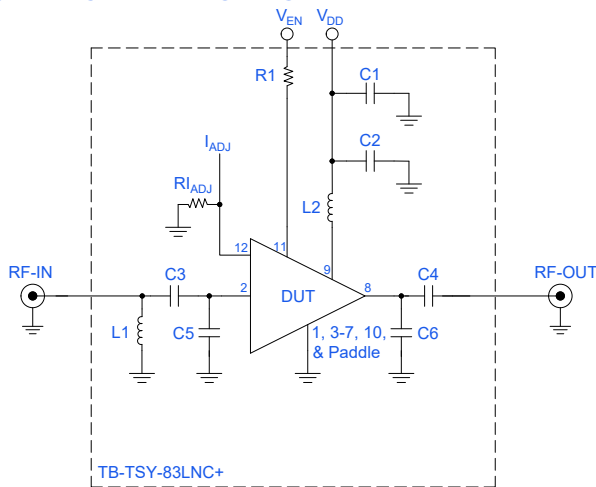

Figure 2. TSY-83LN+ Wide Band Characterization and Application Circuit. Used for characterization of device from 0.4 to 6 GHz

Electrical Parameters and Conditions

Gain, Return Loss, Output Power at 1dB Compression (P1dB), Output IP3 (OIP3), and Noise Figure measured using N5242A PNA-X Microwave Network Analyzer.

Conditions:

1. Gain and Return Loss: P_{IN} = -25 dBm
2. Output IP3 (OIP3): Two tones, spaced 1 MHz apart, 0 dBm/Tone at output.

Power ON/Power OFF Sequence

Caution: Permanent damage to the device will occur if the Power ON and Power OFF sequences are not followed.

Power ON:

- 1) Set V_{DD} = +5 or +6 V.
- 2) Set V_{EN} = +5 or +6 V for Amplifier-ON Mode or V_{EN} = 0 V for Bypass Mode.
- 3) Turn on V_{DD} and V_{EN}.
- 4) Apply RF signal.

Power OFF:

- 1) Turn off RF signal.
- 2) Turn off V_{DD} and V_{EN}.

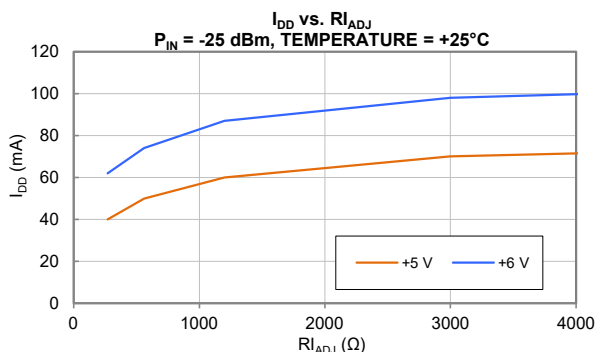

Component	Value	Size	Part Number	Manufacturer
C1	0.01 μF	0402	GRM155R71E103KA01D	Murata
C2	10 pF	0402	GJM1555C1H100JB01D	Murata
C3, C4	100 pF	0402	GRM1555C1H101JA01D	Murata
C5	0.4 pF	0402	GJM1555C1HR40WB01D	Murata
C6	0.3 pF	0402	GJM1555C1HR30WB01D	Murata
R1	0Ω	0402	RK73Z1ETTP	KOA Speer
R _{IADJ} ²⁰	Not Populated	0402	--	--
L1	22 nH	0402	LQG15HS22NG02D	Murata
L2	39 nH	0402	0402CS-39NXGRW	Coilcraft

20. R_{IADJ} resistor not needed for nominal operation. See I_{DD} versus R_{IADJ} plot for typical current consumption.





CHARACTERIZATION BOARD

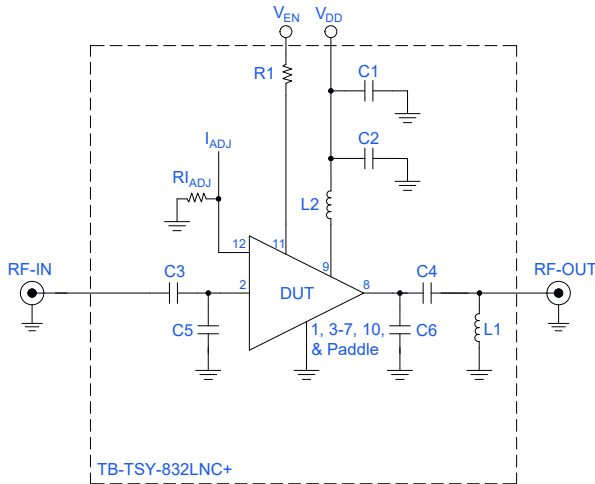

Figure 3. TSY-83LN+ Narrow Band Characterization and Application Circuit. Used for characterization of device from 5.5 to 8 GHz.

Electrical Parameters and Conditions

Gain, Return Loss, Output Power at 1dB Compression (P1dB), Output IP3 (OIP3), and Noise Figure measured using N5242A PNA-X Microwave Network Analyzer.

Conditions:

1. Gain and Return Loss: $P_{IN} = -25$ dBm
2. Output IP3 (OIP3): Two tones, spaced 1 MHz apart, 0 dBm/Tone at output.

Component	Value	Size	Part Number	Manufacturer
C1	0.01 μ F	0402	GRM155R71E103KA01D	Murata
C2	10 pF	0402	GJM1555C1H100JB01D	Murata
C3, C4	100 pF	0402	GRM1555C1H101JA01D	Murata
C5	0.4 pF	0402	GJM1555C1HR40WB01D	Murata
C6	0.3 pF	0402	GJM1555C1HR30WB01D	Murata
R1	0 Ω	0402	RK73Z1ETTP	KOA Speer
$R_{I_{ADJ}}$ ²¹	Not Populated	0402	--	--
L1	2 nH	0402	0402CS-2N0XGRW	Coilcraft
L2	5.6 nH	0402	0402CS-5N6XGRW	Coilcraft

21. A_{DD} resistor not needed for nominal operation. See I_{DD} versus $R_{I_{ADJ}}$ plot for typical current consumption.



MMIC SURFACE MOUNT

Low Noise Amplifier

TSY-83LN+

Mini-Circuits

50Ω 0.4 to 8 GHz Bypass Mode Feature

CASE STYLE DRAWING

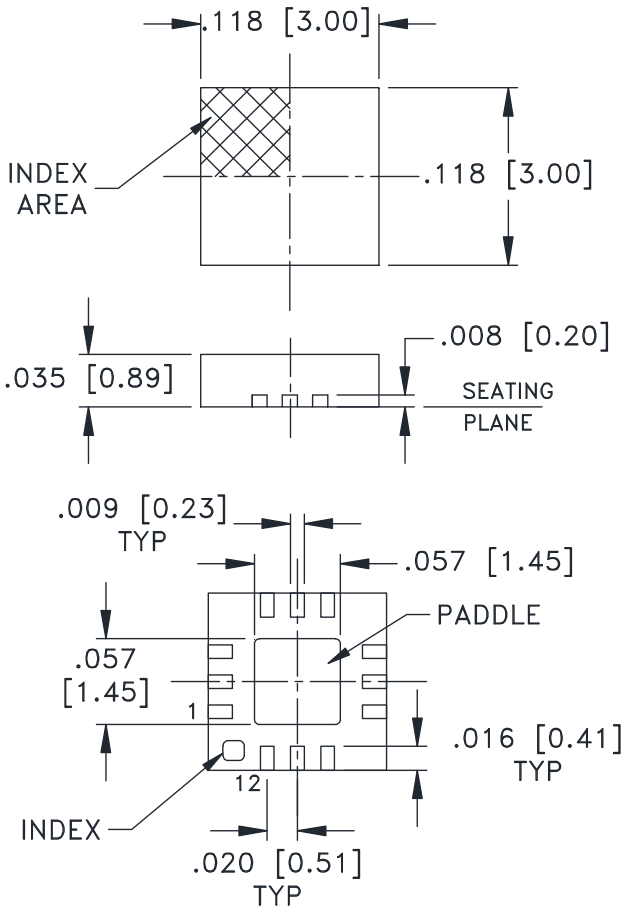

PCB Land Pattern

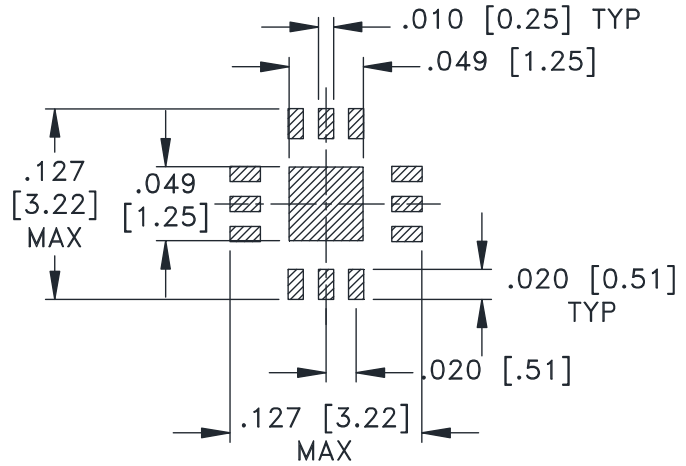

SUGGESTED LAYOUT,
TOLERANCE TO BE WITHIN ±.002

Weight: .02 Grams

Dimensions are in inches [mm]. Tolerances in inches: 2 Pl. ±.01; 3 Pl.±.004

PRODUCT MARKING

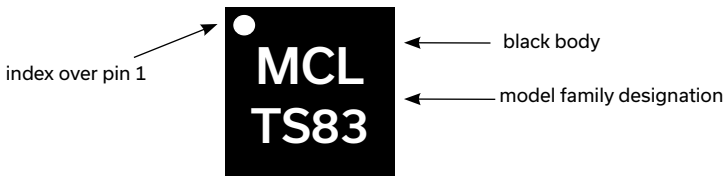

Marking may contain other features or characters for internal lot control

Mini-Circuits



MMIC SURFACE MOUNT

Low Noise Amplifier

TSY-83LN+

50Ω 0.4 to 8 GHz Bypass Mode Feature

ADDITIONAL DETAILED TECHNICAL INFORMATION IS AVAILABLE ON OUR DASH BOARD. TO ACCESS [CLICK HERE](#)

Performance Data and Graphs	Data Table Swept Graphs S-Parameter (S2P Files) Data Set (.zip file)
Case Style	DQ1225. Plastic package, exposed paddle, Lead Finish: Matte-Tin
RoHS Status	Compliant
Tape & Reel Standard quantities available on reel	F66 7" reels with 20, 50, 100, 200, 500, 1000, 2000, or 3000 devices
Suggested Layout for PCB Design	PL-775
Evaluation Board	TB-TSY-83LNC+ (Wide Band, 0.4 to 6 GHz) TB-TSY-832LNC+ (Narrow Band, 5.5 to 8 GHz) Gerber File
Environmental Ratings	ENV08T1

NOTES

- A. Performance and quality attributes and conditions not expressly stated in this specification document are intended to be excluded and do not form a part of this specification document.
- B. Electrical specifications and performance data contained in this specification document are based on Mini-Circuit's applicable established test performance criteria and measurement instructions.
- C. The parts covered by this specification document are subject to Mini-Circuits standard limited warranty and terms and conditions (collectively, "Standard Terms"); Purchasers of this part are entitled to the rights and benefits contained therein. For a full statement of the standard terms and the exclusive rights and remedies thereunder, please visit Mini-Circuits' website at www.minicircuits.com/terms/viewterm.html

