



COAXIAL

Active Power Splitter

SPL-2G42G50W4+

50Ω 2.4 to 2.5 GHz 360° Variable Phase Shift 30 dB, 0.5 dB steps MCX-Female

THE BIG DEAL

- 2.4 to 2.5 GHz ISM band
- 30 dB attenuation range
- 360° phase shift range
- Suitable for CW and pulsed signals
- Easy integration with ZHL-2425-250X+ and ISC-2425-25+
- I2C control interface
- Isolated Paths

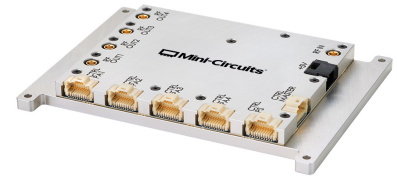

Generic photo used for illustration purposes only

APPLICATIONS

- RF energy generators
- Industrial heating
- Plasma generators
- S-band high-power amplifiers

FUNCTIONAL DIAGRAM

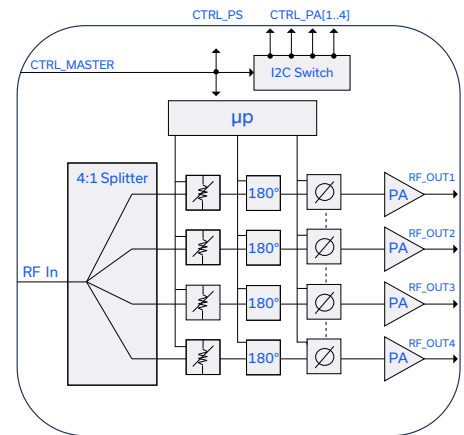

PRODUCT OVERVIEW

The SPL-2G42G50W4+ is a 4-way RF splitter for the 2.4-2.5 GHz ISM band. The splitter is capable of more than 360° of phase shift with 1° tuning resolution. Each path also has an amplitude tuning range of 30 dB with a step size of 0.5 dB. The total phase shift of the unit is accomplished with a 160° continuously variable phase shifter coupled with a 180° phase inversion bit. This unit can be used to easily construct a 1KW RF energy system built with 4x ZHL-2425-250X+, the ISC-2425-25+ and the COM-2G42G51K0+.

KEY FEATURES

Features	Advantages
Gain Variation	30 dB of variable Gain with 0.5 dB step size, individually controlled per channel.
Phase Variation	360° phase shift, 160° with 1° resolution and a 180° phase inversion bit
I2C bus	I2C bus for control of the phase and amplitude. The bus is switchable and provides 4 outputs for controlling 4 amplifiers and one peripheral component such as a power supply
Easy interfacing	Easy access to the amplifiers analog and digital (I2C) data, enabling dynamic ISM applications with either single or multiple modules to be controlled

REV. OR
ECO-020105
SPL-2G42G50W4+
MCL NY
231219



**COAXIAL**

Active Power Splitter **SPL-2G42G50W4+**

50Ω 2.4 to 2.5 GHz 360° Variable Phase Shift 30 dB, 0.5 dB steps MCX-Female

ELECTRICAL SPECIFICATIONS AT $T_{BASE} = +25^{\circ}C$ $V_{DS} = 5V$

Parameter	Frequency (MHz)	Min.	Typ.	Max.	Units
Frequency Range	-	2400	-	2500	MHz
Insertion Loss ^{1,2}	2400-2500	-	1	2	dB
Continuous Phase Adjustment ³	2400-2500	155	165	-	Degree
Phase Resolution	2400-2500	-	1	-	Degree
180 degree Phase BIT ^{1,3}	2400-2500	165	180	-	Degree
Amplitude Adjustment ⁴	2400-2500	30	-	-	dB
Amp Resolution	2400-2500	-	0.5	-	Degree
VSWR (RF_IN)	2400-2500	-	-	2.3	:1
VSWR (RF_OUT)	2400-2500	-	-	2.0	:1
Supply Current	2400-2500	-	650	-	mA

1. All ports must be terminated with 50 Ω
2. Across all DAC values
3. AMPLITUDE DAC = 0
4. PHASE DAC = 0

ABSOLUTE MAXIMUM RATINGS⁵

Parameter	Ratings
Operating Base Temperature ⁵	0°C to 85°C
Storage Temperature	-55 °C to 100 °C
Power Input ⁶	+18 dBm
Voltage	5.5 V

5. Permanent damage may occur if any of these limits are exceeded.
6. 10 minutes test time at 2500 MHz

APPLICATION OVERVIEW

The SPL-2G42G504W+ was designed to be integrated with the ZHL-2425-250X+, the ISC-2425-25+, and the COM-2G42G51K0+. The SPL-2G42G504W+ is designed to enable matching of the phase and amplitude of the four independent paths of the system. The cables, ZHL-2425-250X+ and the COM-2G42G51K0+ all have their individual phase and amplitude differences which can be overcome by the adjustment of the channels in the SPL-2G42G504W+. The bidirectional control from each ZHL-2425-250X+ is input on each of the four CTRL_PA [1..4] inputs and are routed through to the CTRL_MASTER which interfaces with the ISC-2425-25+. There is a control signal that routes the I2C communication to an external component, in many instances this is a power supply feeding the 4 x ZHL-2425-250X+.

Every ZHL-2425-250X+ comes preprogrammed from the factory with the same address. To access the individual ZHL-2425-250X+ amplifiers, they all need to have their own unique address. The SPL-2G42G50W5+ has an in-line I2C switch that allows the selection of individual PA channels, so they can be programmed with an unique address. This programming function is available through the CTRL_MASTER port which connects to the CTRL_PA[1..4] ports iteratively. This function is most useful at initial system configuration.

Once the addresses have been configured the ZHL PA's will have their new address after the next V_{DD} power cycle. It is important to note that the I2C switch has all I2C paths open on startup and an enable command has to be sent to choose individual channels or turn all channels on 0x700Fh.





COAXIAL

Active Power Splitter

SPL-2G42G50W4+

50Ω 2.4 to 2.5 GHz 360° Variable Phase Shift 30 dB, 0.5 dB steps MCX-Female

I2C BUS

The SPL-2G42G50W4+ has six I2C interfaces, there are 3 different types that the i2C bus resides on. The first type of interface is the main interface CTRL_MASTER, this interface controls a switch that routes the I2C bus to the four external PA control connectors CTRL_PA[1..4]. The 2nd type of interface is replicated four times to interface to external PAs such as the ZHL-2425-250X+. The third interface simply routes the I2C bus directly from the CTRL_MASTER. The pinout and function of these interfaces is described in the tables below.

CONTROL INTERFACE PIN-OUT AND FUNCTIONALITY FOR CONNECTORS CTRL_MASTER, CTRL_PA1, CTRL_PA2, CTRL_PA3, CTRL_PA4

Pin Number	Label	Type	Functionality and Control
1	PIN1		Connected through to Pin 1 CTRL PA1, PA2, PA3, PA4
2	PIN2		Connected through to Pin 2 CTRL PA1, PA2, PA3, PA4
3	PIN3		Connected through to Pin 3 CTRL PA1, PA2, PA3, PA4
4	PIN4		Connected through to Pin 4 CTRL PA1, PA2, PA3, PA4
5	PIN5		Connected through to Pin 5 CTRL PA1, PA2, PA3, PA4
6	PIN6		Connected through to Pin 6 CTRL PA1, PA2, PA3, PA4
7	Do Not Connect		Reserved pin for manufacturer
8	PIN8		Connected through to Pin 8 CTRL PA1, PA2, PA3, PA4
9	PIN9		Connected through to Pin 9 CTRL PA1, PA2, PA3, PA4
10	GND		Ground
11	Do Not Connect		Reserved pin for manufacturer
12	GND		Ground
13	SCL		I2C control
14	PIN14		Connected through to Pin 14 CTRL PA1, PA2, PA3, PA4
15	SDA		I2C control
16	GND		Ground
17-20	Do Not Connect		Reserved pin for manufacturer

(CTRL_PS) CONTROL INTERFACE PIN-OUT AND FUNCTIONALITY

Pin Number	Label	Type	Functionality and Control
1-9,11,14,17-20	No connect		
10,12,16	GND		Ground
13	SCL		I2C control
15	SDA		I2C control





COAXIAL

Active Power Splitter

SPL-2G42G50W4+

50Ω 2.4 to 2.5 GHz 360° Variable Phase Shift 30 dB, 0.5 dB steps MCX-Female

REGISTER TABLE

Register #	Function	Range
0x6008h	Set Attenuation, Channel 1	0-63, 0.5dB per LSB
0x6028h	Set Attenuation, Channel 2	0-63, 0.5dB per LSB
0x6030h	Set Attenuation, Channel 3	0-63, 0.5dB per LSB
0x6010h	Set Attenuation, Channel 4	0-63, 0.5dB per LSB
0x6018h	Set Phase, Channel 1	0-255 controls the variable phase shift in ~1° steps per LSB. Setting 256 flips the 180° bit and restarts the variable phase shifter. Full range of this command is 0-511
0x6038h	Set Phase, Channel 2	0-255 controls the variable phase shift in ~1° steps per LSB. Setting 256 flips the 180° bit and restarts the variable phase shifter. Full range of this command is 0-511
0x6020h	Set Phase, Channel 3	0-255 controls the variable phase shift in ~1° steps per LSB. Setting 256 flips the 180° bit and restarts the variable phase shifter. Full range of this command is 0-511
0x6000h	Set Phase, Channel 4	0-255 controls the variable phase shift in ~1° steps per LSB. Setting 256 flips the 180° bit and restarts the variable phase shifter. Full range of this command is 0-511
0x600Eh	Read Attenuation, Channel 1	[MSB,LSB]
0x602Eh	Read Attenuation, Channel 2	[MSB,LSB]
0x6036h	Read Attenuation, Channel 3	[MSB,LSB]
0x6016h	Read Attenuation, Channel 4	[MSB,LSB]
0x601Eh	Read Phase, Channel 1	[MSB,LSB]
0x603Eh	Read Phase, Channel 2	[MSB,LSB]
0x6026h	Read Phase, Channel 3	[MSB,LSB]
0x6006h	Read Phase, Channel 4	[MSB,LSB]
0x7001h	Enable I2C, Channel 1 Only	Enable the control PA1 path
0x7002h	Enable I2C, Channel 2 Only	Enable the control PA2 path
0x7003h	Enable I2C, Channel 3 Only	Enable the control PA3 path
0x7004h	Enable I2C, Channel 4 Only	Enable the control PA4 path
0x700Fh	Enable all I2C, Channels	Enables all I2C paths
0x6070Fh	Assert (Enable) RFEN	
0x6078Fh	De-assert (Disable) RFEN	





COAXIAL

Active Power Splitter

SPL-2G42G50W4+

50Ω 2.4 to 2.5 GHz 360° Variable Phase Shift 30 dB, 0.5 dB steps MCX-Female

TYPICAL PERFORMANCE DATA ACROSS FREQUENCY AT DIFFERENT DAC VALUES ($T_{BASE} = 25^{\circ}C$, 50 Ω SYSTEM, $V_{DS} = 5$ V TYP., $I_{DC} = 650$ mA TYP.)

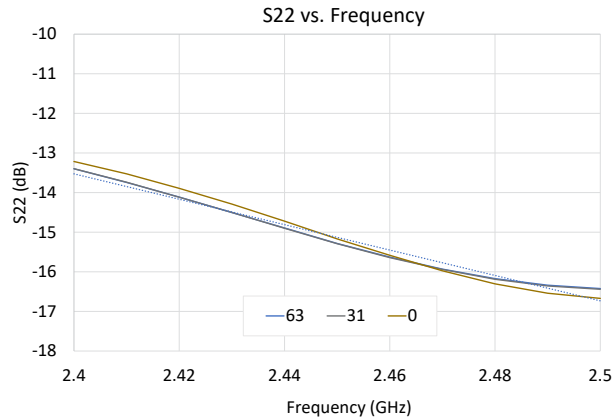
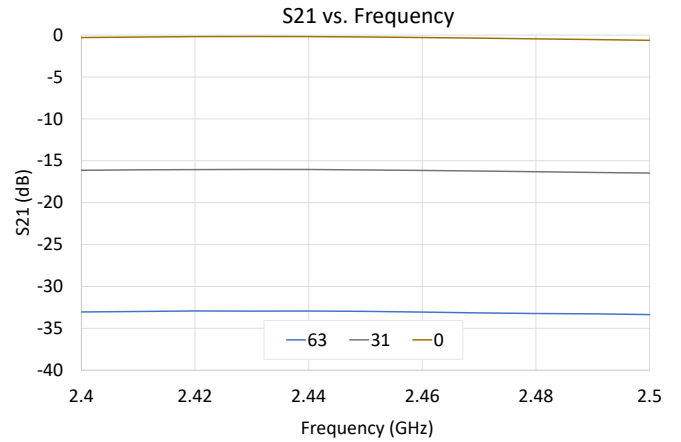
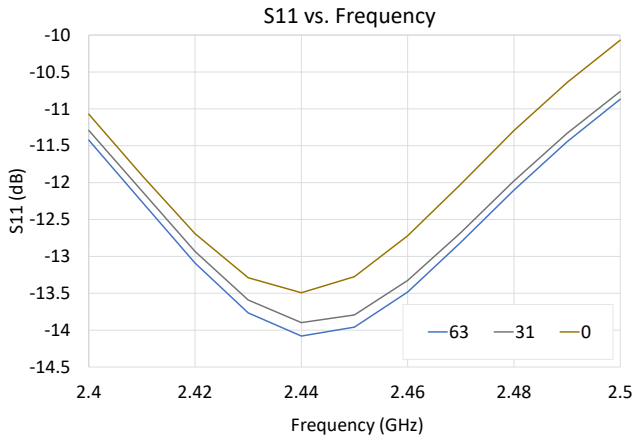



COAXIAL

Active Power Splitter

SPL-2G42G50W4+

50Ω 2.4 to 2.5 GHz 360° Variable Phase Shift 30 dB, 0.5 dB steps MCX-Female

TYPICAL PERFORMANCE DATA ACROSS FREQUENCY AT DAC VALUE 0 ($T_{BASE} = 0^{\circ}C, 25^{\circ}C, 85^{\circ}C$, 50 Ω SYSTEM, $V_{DS} = 5$ V TYP., $I_{DC} = 650$ mA TYP.)

S11 vs. Frequency

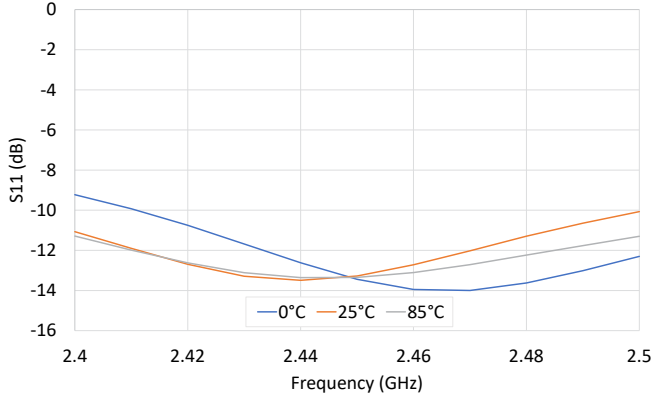

S22 vs. Frequency

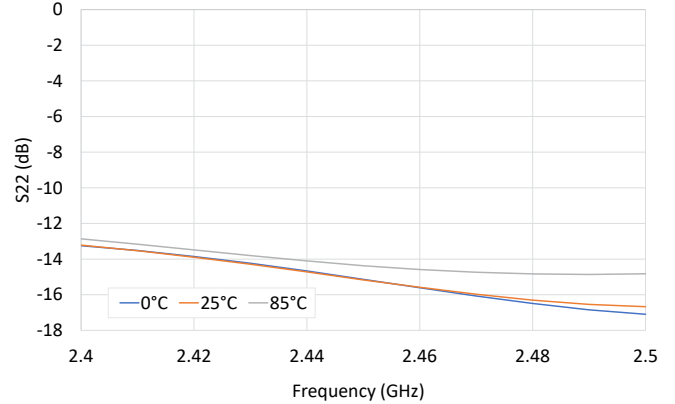

Attenuation level S21 vs. Frequency

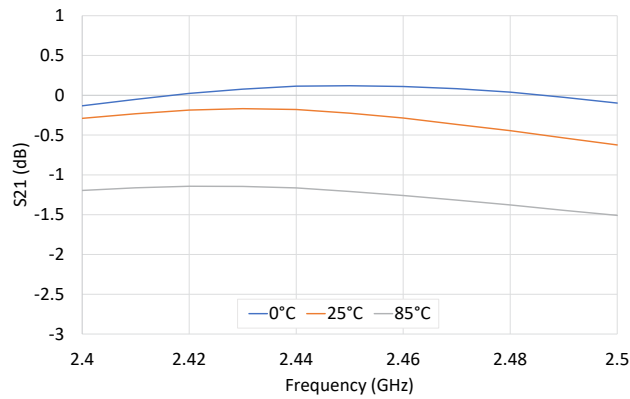



COAXIAL

Active Power Splitter

SPL-2G42G50W4+

50Ω 2.4 to 2.5 GHz 360° Variable Phase Shift 30 dB, 0.5 dB steps MCX-Female

TYPICAL PERFORMANCE DATA ACROSS TEMPERATURE (50 Ω SYSTEM, $V_{DS}=5$ V TYP., $I_{DC}=650$ mA TYP.)

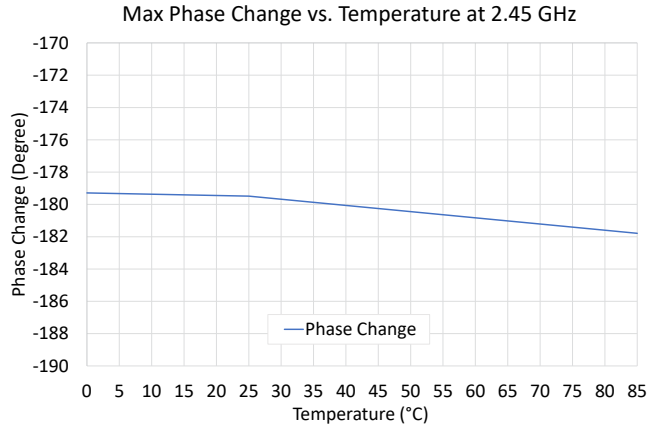

TYPICAL PERFORMANCE DATA ACROSS FREQUENCY ($T_{BASE}=25^{\circ}\text{C}$, 50 Ω SYSTEM, $V_{DS}=5$ V TYP., $I_{DC}=650$ mA TYP.)

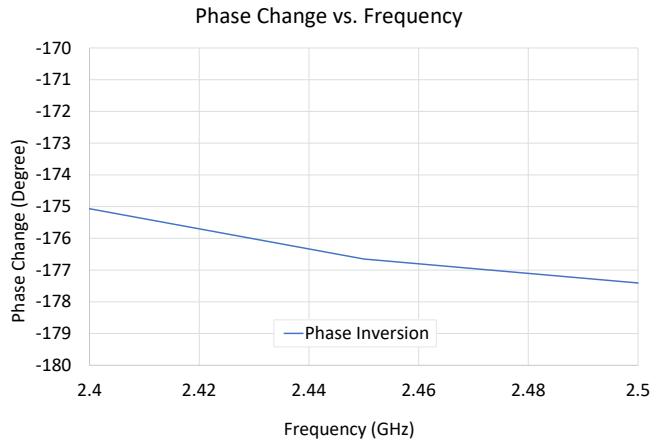



COAXIAL

Active Power Splitter

SPL-2G42G50W4+

Mini-Circuits

50Ω 2.4 to 2.5 GHz 360° Variable Phase Shift 30 dB, 0.5 dB steps MCX-Female

COAXIAL CONNECTIONS

Input / Output	MCX-Female

CASE STYLE DRAWING

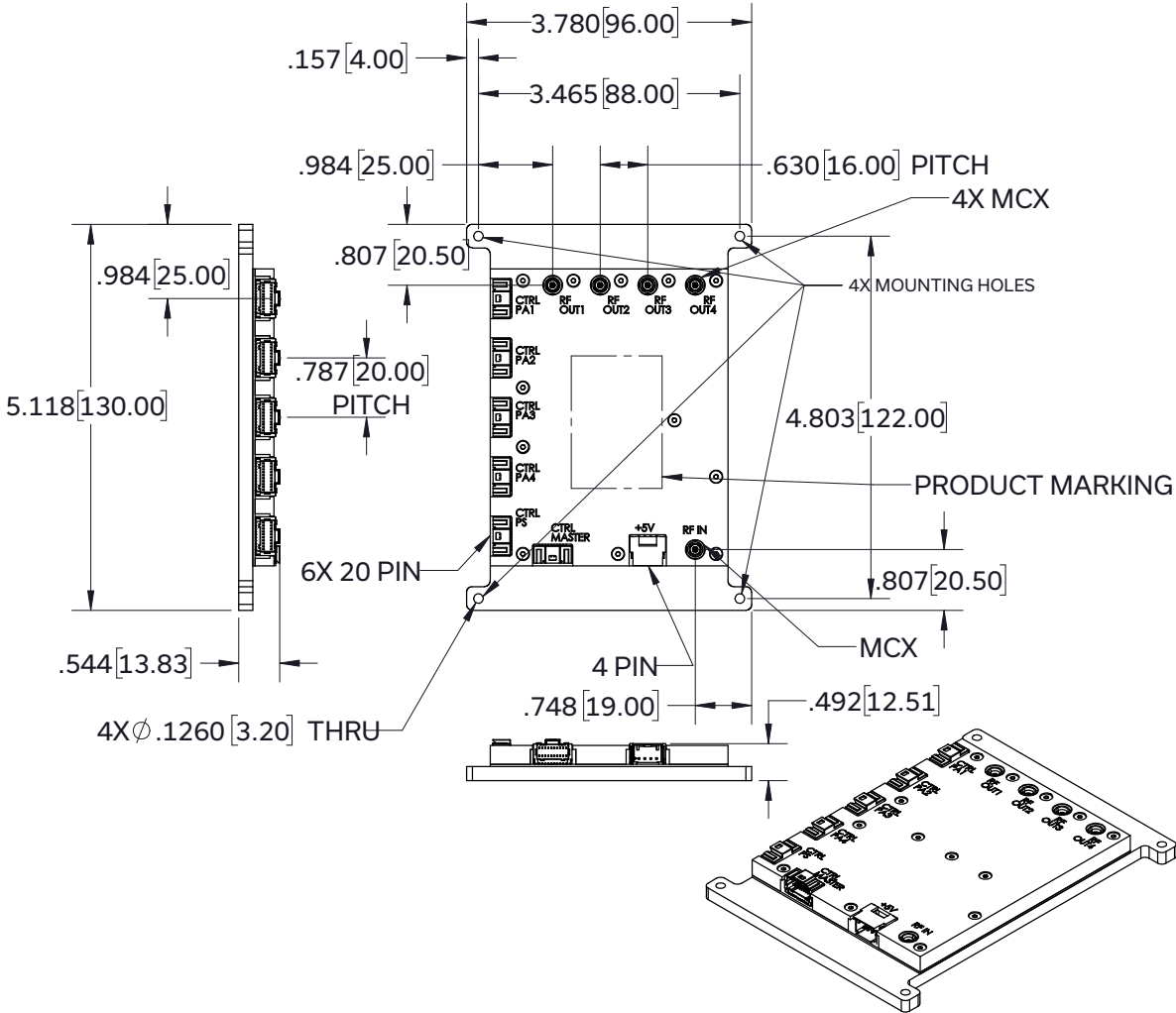

Weight: 220 grams

Dimensions are in inches [mm]. Tolerances: 2 Pl. ±0.03 inch; 3 Pl. ±0.015 inch

Recommended screws for mounting model : Use M3 button head

PRODUCT MARKING*: SPL-2G42G50W4+

*Marking may contain other features or characters for internal lot control.



COAXIAL

Active Power Splitter **SPL-2G42G50W4+**

50Ω 2.4 to 2.5 GHz 360° Variable Phase Shift 30 dB, 0.5 dB steps MCX-Female

ADDITIONAL INFORMATION IS AVAILABLE ON OUR DASHBOARD

Performance Data & Graphs	Data Graphs
Case Style	VU3558
RoHS Status	Compliant
Environmental Ratings	ENV28T22

ORDERING INFORMATION

Model No. Links	SPL-2G42G50W4+
Product Marking	SPL-2G4250W4+
Case Style	VU3558
Connectors	MCX-Female



COAXIAL

Active Power Splitter

SPL-2G42G50W4+

50Ω 2.4 to 2.5 GHz 360° Variable Phase Shift 30 dB, 0.5 dB steps

SAFETY INSTRUCTIONS.

WARNING: FAILURE TO FOLLOW THESE INSTRUCTIONS MAY RESULT IN BODILY INJURY, DEATH, OR PROPERTY DAMAGE.

For your own safety, this section provides instructions for avoiding potential dangers when using this product.

QUALIFIED PERSONNEL

This product should be operated by qualified personnel only. Qualified personnel are individuals who are familiar with the operation of the product and the hazards involved with such operation.

DAMAGED OR MISSING HARDWARE

Do not operate the product if there is physical damage or hardware is missing.

MAXIMUM RATINGS

The maximum ratings in this data sheet should never be exceeded. Stress above one or more maximum ratings may cause permanent damage to the product and may permanently and irreversibly affect the quality and reliability of the product, which may increase the risk of bodily injury, death, or property damage.

HAZARDOUS RF VOLTAGES

The RF voltages inside the product and on the center pin of the RF output connector can be hazardous. Contact with the internal components of the product or the center pin of the RF output connector may lead to burns or electrical shock. Disconnect power before removing the protective cover from the product. Note that removing the protective cover from the product will void the express warranty specified in Mini-Circuits Standard Terms.

To reduce the risks presented by these hazards:

1. never operate the product without its protective cover,
2. always connect the RF output connector to a load before the power source is applied to the product, and
3. always place the product in a non-operating condition before disconnecting or connecting the load to the RF output connector.

COOLING

RF Power amplifiers always need proper cooling. Failure to properly cool the product may increase the risk of bodily injury, death, or damage to property or the product.

Some products contain water cooling systems to help cool down the product. If this data sheet indicates that the product contains a water cooling system, proper waterflow as specified in this data sheet is required to keep the temperature of the product within the temperature range that is specified in this data sheet.

Some products also contain built-in protection circuitry designed to shut-off the amplifier at excessive high temperatures or at other excessive operating conditions. Even if this data sheet indicates that the product contains protective circuitry, such protective circuitry is not a substitute for proper handling in accordance with these instructions. Accordingly, do not rely on the protective circuitry to prevent injury or damage to property or the product.

MAINTENANCE CAUTION

Maintenance or repair of the product must only be performed by qualified personnel when the product is in a non-operating condition and disconnected from its power source. Note that performance of maintenance or repairs to the product will void the express warranty specified in Mini-Circuits Standard Terms.

ENVIRONMENTAL CONDITIONS

Unless otherwise stated in this data sheet, this product is designed to be operated under the environmental conditions set forth in this data sheet, as well as the following conditions:

- Indoor use only
- Temperature of 5°C to 40°C (non-condensing)

WARNING SIGNS

In addition to being qualified before operating the product, pay attention to all warning signs and danger symbols. Failure to heed warnings signs and danger symbols, or to follow their associated instructions, may result in bodily injury, death, or property damage.

NOTES

- A. Performance and quality attributes and conditions not expressly stated in this specification document are intended to be excluded and do not form a part of this specification document.
- B. Electrical specifications and performance data contained in this specification document are based on Mini-Circuit's applicable established test performance criteria and measurement instructions.
- C. The parts covered by this specification document are subject to Mini-Circuits standard limited warranty and terms and conditions (collectively, "Standard Terms"); Purchasers of this part are entitled to the rights and benefits contained therein. For a full statement of the standard terms and the exclusive rights and remedies thereunder, please visit Mini-Circuits' website at www.minicircuits.com/terms/viewterm.html

