

Programmable Attenuator

RCDAT-6G-120H

50Ω 0 – 120 dB, 0.05 dB step 200 to 6000 MHz

The Big Deal

- Wide attenuation range, 120 dB
- Fine attenuation resolution, 0.05 dB
- Short attenuation transition time (200 ns)
- Compact size, 2.5 x 3.0 x 0.85"
- **USB and Ethernet control**



Software Package

Case Style: MS1897

Applications

- Signal level calibration
- Automated gain control
- LTE, 5G, DVB fading simulators
- Laboratory instrumentation
- Wi-Fi device testing

Included Accessories

Model No.	Description	Qty.
MUSB-CBL-3+	3.3 ft. USB cable	1

RoHS Compliant

See our web site for RoHS Compliance methodologies and qualifications

Product Overview

Mini-Circuits' RCDAT-6G-120H is a general purpose, single channel programmable attenuator suitable for a wide range of signal level control applications from 200 MHz to 6 GHz. The Attenuator provides 0 to 120 dB attenuation in 0.05 dB steps. Its unique design maintains linear attenuation change per dB, even at the highest attenuation settings.

The attenuator is housed in a compact and rugged package with SMA female connectors on the bi-directional input and output RF ports, a standard Ethernet port (RJ45) and a USB type Mini-B power and control port.

The attenuator can be controlled via USB or Ethernet (supporting HTTP, Telnet and SSH network protocols). Full software support is provided and can be downloaded from our website any time at <http://www.minicircuits.com/softwaredownload/patt.html>. The package includes our user-friendly GUI application for Windows® and a full API with programming instructions for Windows® and Linux® environments (both 32-bit and 64-bit systems).

Key Features

Feature	Advantages
USB & Ethernet control	USB HID and Ethernet (HTTP / Telnet / SSH) interfaces provide easy compatibility with a wide range of software setups and programming environments. The device draws all power requirements through the USB port.
Programmable attenuation sweep and Hop sequences	The RCDAT-6G-120H can be programmed with a timed sequence of attenuation settings, to run without any additional external control.
120 dB attenuation range.	The RCDAT-6G-120H provides high-accuracy attenuation up to 120 dB in 0.05 dB steps, allowing the user precise level control over a broad attenuation and frequency range.
High linearity	Typical input IP3 of +51 dBm up to 6000 MHz.

Trademarks: Windows is a registered trademark of Microsoft Corporation in the United States and other countries. Linux is a registered trademark of Linus Torvalds. Mac is a registered trademark of Apple Corporation. SSH is a registered trademark of SSH Communications Security Corp. Pentium is a registered trademark of Intel Corporation. Neither Mini-Circuits nor the Mini-Circuits RCDAT-series attenuators are affiliated with or endorsed by the owners of the above referenced trademarks.

Mini-Circuits and the Mini-Circuits logo are registered trademarks of Scientific Components Corporation.



Electrical Specifications ¹ at +25°C

Parameter	Frequency range	Conditions	Min.	Typ.	Max.	Units
Attenuation range	200 - 6000 MHz	0.05 dB step	0	-	105	dB
		0.10 dB step	105		120	
Attenuation setting accuracy ^{2, 3}	200 - 6000 MHz	@ 0.05 - 30 dB	-	±0.30	±(1.25+1.5% of nominal value)	dB
		@ 30.05 - 60 dB	-	±0.45	±1.8	
		@ 60.05 - 90 dB	-	±0.70	±(0.3+2.5% of nominal value)	
		@ 90.05 - 110 dB	-	±1.35	±(-5+9% of nominal value)	
		@ 110.10 - 120 dB	-	±2.10	±6.0	
Insertion Loss	200 - 2000 MHz	@ 0 dB	-	5.5	7.0	dB
	2000 - 4000 MHz		-	7.4	9.0	
	4000 - 6000 MHz		-	9.3	11.3	
Isolation In-Out	200 - 6000 MHz	Note 4	-	125	-	dB
Input operating power ⁵ (RF In and RF Out ports)	200 - 6000 MHz	@ 0 - 120 dB	-	-	+23	dBm
IP3 Input ⁶	200 - 6000 MHz	@ 0 dB setting (P _{IN} =+5 dBm)	-	+51	-	dBm
VSWR	200 - 6000 MHz	@ 0 - 15 dB	-	1.30	-	:1
		@ 15.05 - 120 dB	-	1.15	-	
Min Dwell Time ⁷	200 - 6000 MHz	High speed mode	-	600	-	µsec
Attenuation Transition Time ⁸	200 - 6000 MHz	to ±0.25 dB of final value	-	200	-	nSec
Supply Voltage	-	via USB port	4.75	5	5.25	V
USB current draw	-	-	-	210	330	mA
Ethernet Communication	Protocol	TCP / IP, HTTP, Telnet, SSH, DHCP, UDP (limited)				
	Max Data Rate	100 Mbps (100 Base-T Full Duplex)				
USB Communication	Protocol	HID (Human Interface Device) - High Speed				
	Min Communication Time ⁹	400 µs Typ (full transmit/receive cycle)				

¹ Attenuator RF ports are interchangeable, and support simultaneous, bidirectional signal transmission, however the specifications are guaranteed for the RF in and RF out as noted on the label. There may be minor changes in performance when injecting signals to the RF Out port.

² See pages 5-7 for performance data.

³ Max setting accuracy defined as ±[absolute error+% of attenuation setting] for example when setting the attenuator to 115 dB attenuation the maximum error at 5500 MHz will be: ±(-16+0.19x115)= ±(-16+21.85)= ± 5.85 dB

⁴ Isolation is defined as max attenuation plus insertion loss; this is the path loss through the attenuator when initially powered up. After a brief delay (~0.5 sec typically) the attenuator will revert to a user defined "power-up" state (either max attenuation or a pre-set value).

⁵ Total operating input power from both RF In and RF Out out ports. Compression level not noted as it exceeds max safe operating power level.

⁶ IP3 tested with 1 MHz span between signals.

⁷ Minimum Dwell Time is the time the RCDAT will take to respond to a command to change attenuation states without communication delays. In PC control add communication delays (on the order of msec for USB) to get actual response time.

⁸ Attenuation Transition Time is specified as the time between starting to change the attenuation state and settling on the requested attenuation state.

⁹ USB min communication time is based on the polling interval of the USB HID protocol(125 µs polling interval, 1024 bytes per packet), medium CPU load and no other high speed USB devices using the USB bus.

Connections

RF In	(SMA female)
RF Out	(SMA female)
USB	(USB type Mini-B female)
Network (Ethernet/LAN)	(RJ45 socket)

Absolute Maximum Ratings

Operating Temperature	0°C to 50°C
Storage Temperature	-20°C to 85°C
V _{USB} Max.	6V
DC voltage at RF port	25V
Total RF power for RF In & RF Out	+26 dBm

Permanent damage may occur if any of these limits are exceeded. Operating in the range between operating power limits and absolute maximum ratings for extended periods of time may result in reduced life and reliability.

RCDAT response to communication interrupt

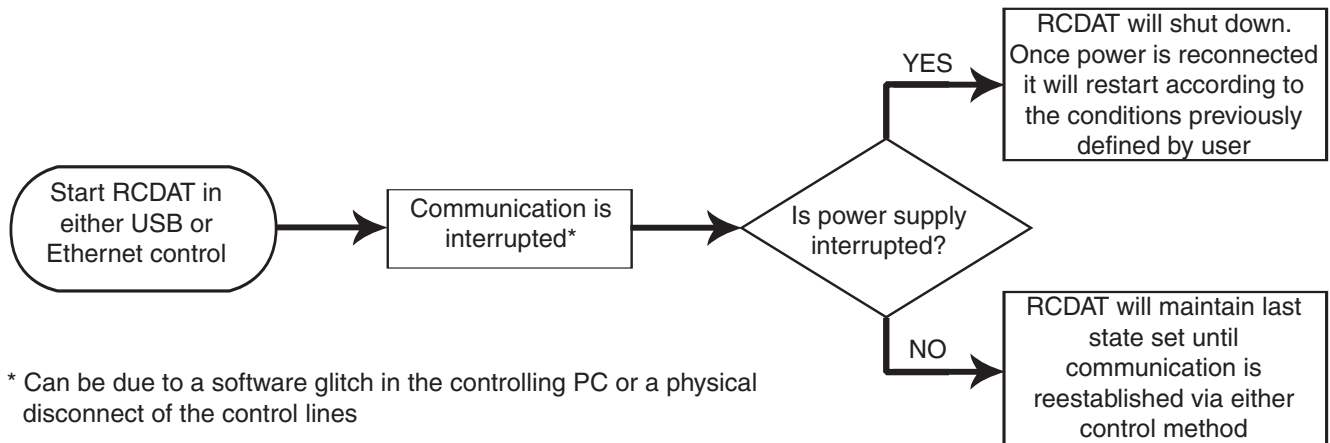

Block Diagram

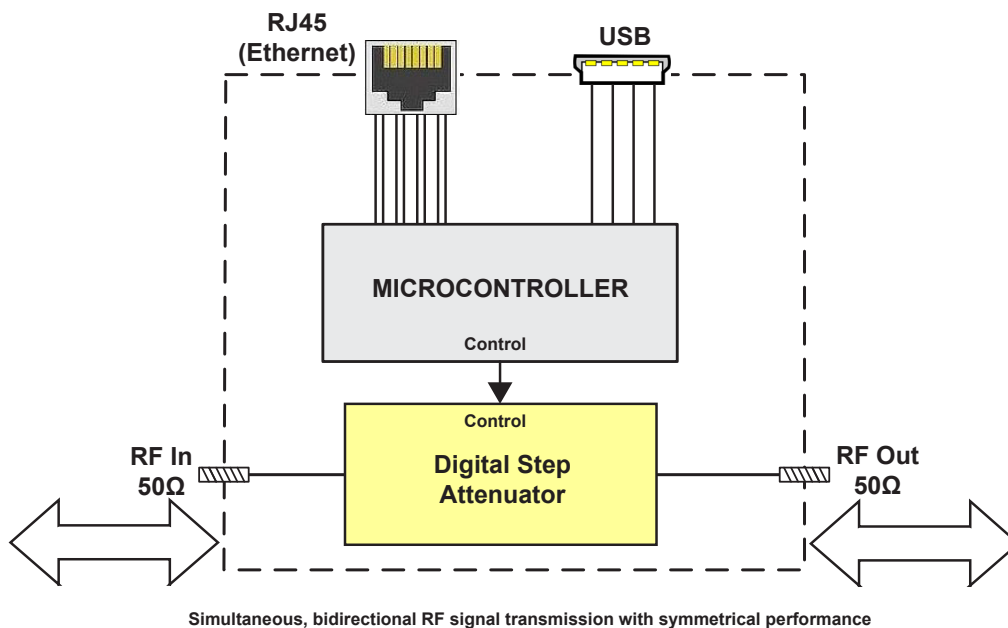

Outline Drawing (MS1897)

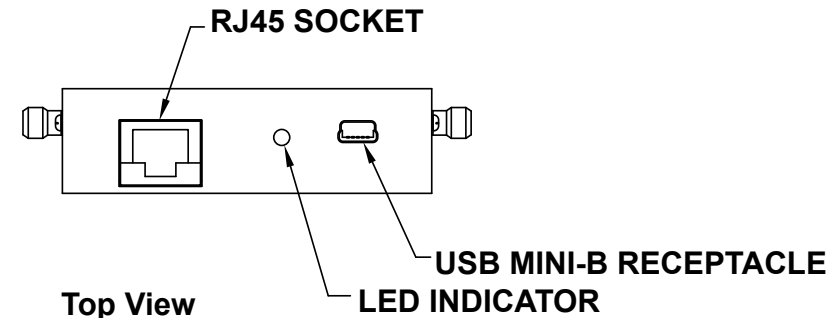

Top View

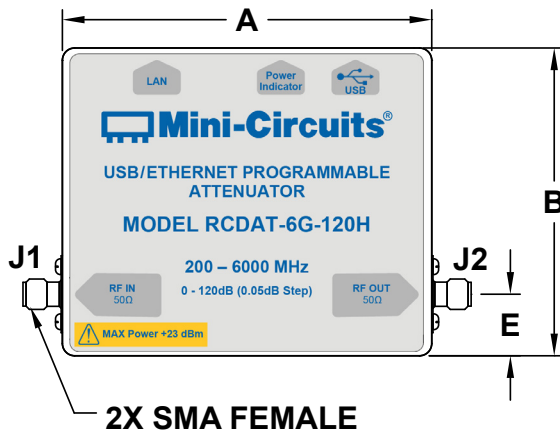

Bottom View

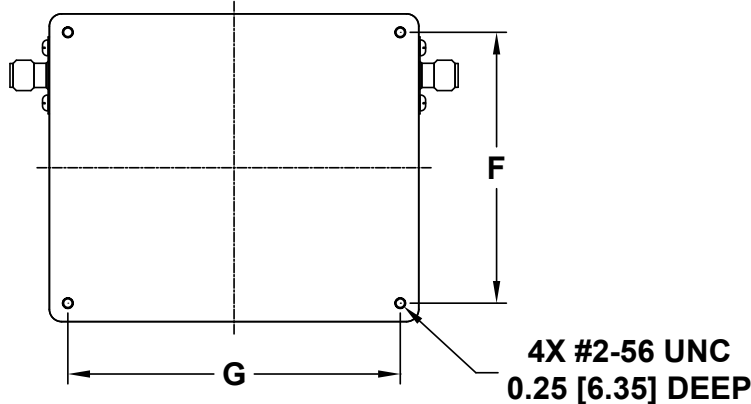
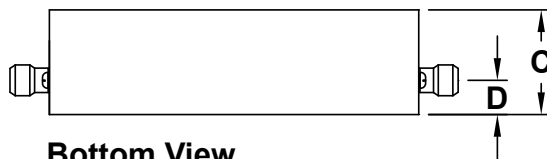

Connections

RF IN	(SMA female)
RF OUT	(SMA female)
USB	(USB type Mini-B female)
Network (Ethernet/LAN)	(RJ45 socket)

Bracket Option

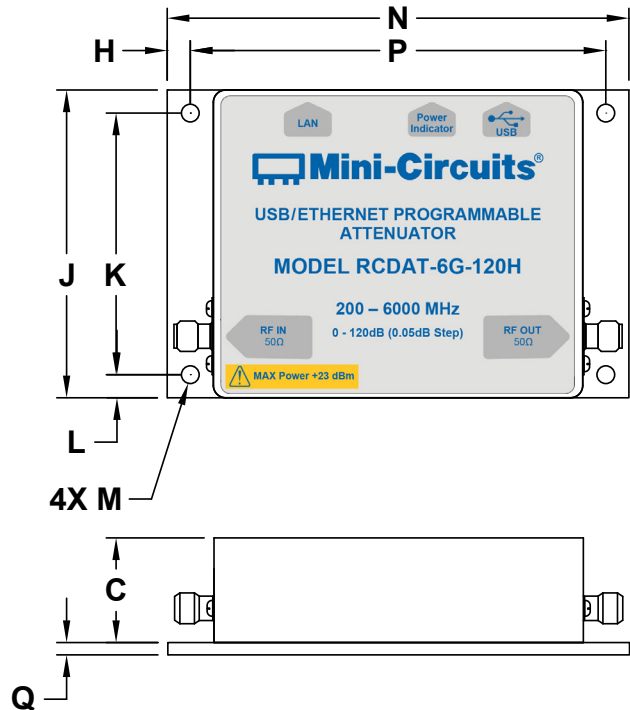

Instruction for mounting bracket:

1. Tool required: Phillips head screwdriver
2. Mount the bracket over threaded holes on the bottom side with the fasteners provided with the bracket.

Outline Dimensions (inch mm)

A	B	C	D	E	F	G	H	J	K	L	M	N	P	Q	WT. GRAMS
3.00	2.50	0.85	0.28	0.50	2.200	2.700	0.188	2.50	2.125	0.188	0.144	3.75	3.375	0.100	200
76.2	63.5	21.3	7.1	12.7	55.88	68.58	4.76	63.5	53.98	4.76	3.66	95.3	85.72	2.54	

Tolerances: inch 2PL. ±0.03 3PL. ±0.015
mm 1PL. ±0.8 2PL. ±0.38

Typical Performance Data @ +25°C

FREQ. (MHz)	I. Loss (dB)	Attenuation relative to I. Loss (dB)												
		@ Attenuation setting (dB)												
		0.25	5	10	20	40	60	80	90	100	105	110	115	120
200	4.18	0.27	5.12	10.15	20.36	40.34	59.36	79.31	89.41	100.11	103.89	108.01	112.40	116.24
250	4.22	0.27	5.11	10.13	20.35	40.29	59.41	79.25	89.35	99.82	103.64	107.79	112.10	115.93
300	4.28	0.27	5.09	10.11	20.34	40.23	59.43	79.15	89.26	99.41	103.35	107.58	111.88	115.81
400	4.42	0.27	5.05	10.05	20.29	40.10	59.36	78.91	88.99	98.93	102.90	107.08	111.44	115.37
500	4.59	0.26	4.99	9.99	20.21	39.98	59.22	78.68	88.76	98.71	102.68	106.83	111.18	114.97
700	4.92	0.26	4.89	9.88	20.06	39.79	59.02	78.49	88.57	98.69	102.77	106.89	111.33	115.24
900	5.20	0.26	4.82	9.83	19.94	39.69	59.06	78.61	88.68	98.93	103.17	107.31	111.67	116.04
1000	5.30	0.26	4.81	9.84	19.92	39.69	59.15	78.74	88.81	99.03	103.39	107.58	112.05	116.19
1200	5.45	0.26	4.83	9.90	19.94	39.73	59.31	78.95	89.00	99.24	103.77	107.94	112.34	116.63
1400	5.55	0.26	4.89	9.99	20.01	39.82	59.38	79.07	89.14	99.49	103.96	108.22	112.61	116.83
1600	5.69	0.27	4.94	10.05	20.09	39.91	59.42	79.15	89.23	99.76	104.12	108.36	112.80	117.13
1800	5.93	0.27	4.97	10.08	20.13	39.95	59.53	79.29	89.39	99.78	104.34	108.60	113.08	117.38
2000	6.21	0.26	4.99	10.08	20.16	39.96	59.64	79.44	89.58	99.80	104.53	108.80	113.15	117.63
2200	6.36	0.26	5.00	10.09	20.18	39.99	59.62	79.46	89.62	100.08	104.62	108.81	113.26	117.86
2400	6.45	0.26	5.02	10.11	20.20	40.02	59.64	79.51	89.68	100.01	104.70	108.91	113.49	118.05
2600	6.58	0.26	5.02	10.13	20.21	40.06	59.75	79.66	89.86	100.23	104.93	109.27	113.91	118.45
2800	6.74	0.26	5.02	10.15	20.22	40.09	59.83	79.77	89.97	100.44	105.13	109.43	114.11	118.72
3000	6.96	0.27	5.00	10.12	20.19	40.09	59.82	79.79	90.00	100.58	105.29	109.56	114.26	118.84
3200	7.22	0.27	4.99	10.08	20.16	40.07	59.81	79.81	90.01	100.60	105.26	109.47	114.07	118.50
3400	7.43	0.27	5.01	10.08	20.17	40.10	59.87	79.88	90.06	100.57	105.29	109.41	113.89	118.26
3600	7.62	0.27	5.05	10.09	20.21	40.15	59.87	79.89	90.09	100.58	105.32	109.53	114.05	118.78
3800	7.83	0.27	5.11	10.09	20.27	40.20	59.91	79.97	90.25	101.05	105.95	110.36	115.51	120.69
4000	7.99	0.27	5.20	10.15	20.38	40.30	59.99	80.09	90.43	101.49	106.33	111.03	116.77	122.90
4200	8.11	0.28	5.31	10.22	20.51	40.41	60.04	80.17	90.59	101.68	106.46	111.13	117.10	122.92
4400	8.26	0.29	5.39	10.26	20.61	40.48	60.11	80.26	90.73	101.68	106.52	111.03	116.69	122.08
4600	8.43	0.30	5.48	10.31	20.71	40.55	60.17	80.34	90.79	101.72	106.49	110.85	116.13	120.73
4800	8.64	0.31	5.51	10.33	20.78	40.60	60.19	80.38	90.85	101.69	106.50	110.93	116.28	121.35
5000	8.92	0.31	5.50	10.31	20.80	40.60	60.21	80.41	90.87	101.78	106.62	111.19	116.75	121.68
5200	9.18	0.32	5.49	10.33	20.82	40.64	60.27	80.48	90.93	101.95	106.43	110.85	115.61	119.94
5400	9.35	0.32	5.51	10.41	20.91	40.74	60.45	80.64	90.94	101.39	106.14	110.21	114.87	119.26
5600	9.56	0.32	5.53	10.51	20.98	40.85	60.64	80.81	91.08	101.50	106.41	110.55	115.29	119.82
5800	9.85	0.34	5.60	10.61	21.02	40.91	60.80	80.95	91.12	101.45	106.64	110.73	115.65	120.34
5900	10.02	0.34	5.65	10.67	21.02	40.93	60.85	80.97	91.13	101.52	106.68	110.67	115.55	120.56
6000	10.20	0.35	5.69	10.72	21.01	40.92	60.88	80.97	91.12	101.52	106.56	110.71	115.74	120.24

FREQ. (MHz)	I. Loss (dB)	Attenuation relative to I. Loss Fine resolution (0.05 dB)														
		@ Attenuation setting (dB)														
		7.40	7.45	7.50	7.55	7.60	67.40	67.45	67.50	67.55	67.60	100.40	100.45	100.50	100.55	100.60
200	4.18	7.59	7.64	7.68	7.74	7.79	67.53	67.58	67.67	67.68	67.73	100.49	100.54	100.64	100.66	100.72
250	4.22	7.58	7.63	7.67	7.72	7.77	67.48	67.54	67.62	67.66	67.69	100.21	100.27	100.35	100.38	100.45
300	4.28	7.56	7.61	7.65	7.70	7.75	67.41	67.47	67.54	67.59	67.62	99.82	99.86	99.95	99.98	100.04
400	4.42	7.51	7.56	7.60	7.66	7.71	67.29	67.35	67.41	67.49	67.51	99.33	99.36	99.44	99.47	99.52
500	4.59	7.46	7.51	7.55	7.60	7.66	67.19	67.24	67.31	67.35	67.38	99.09	99.12	99.21	99.26	99.32
700	4.92	7.38	7.43	7.46	7.52	7.57	67.08	67.11	67.17	67.24	67.26	99.11	99.13	99.21	99.25	99.30
900	5.20	7.35	7.40	7.44	7.49	7.55	67.01	67.09	67.16	67.20	67.22	99.33	99.37	99.44	99.48	99.54
1000	5.30	7.37	7.41	7.45	7.51	7.56	67.03	67.07	67.17	67.20	67.24	99.46	99.47	99.56	99.61	99.64
1200	5.45	7.44	7.48	7.52	7.58	7.63	67.13	67.17	67.22	67.28	67.35	99.67	99.70	99.79	99.84	99.90
1400	5.55	7.53	7.57	7.61	7.67	7.72	67.22	67.31	67.32	67.39	67.42	99.93	99.97	100.02	100.08	100.12
1600	5.69	7.59	7.64	7.68	7.74	7.79	67.34	67.42	67.43	67.50	67.56	100.14	100.20	100.25	100.29	100.36
1800	5.93	7.62	7.67	7.70	7.76	7.81	67.40	67.44	67.49	67.52	67.59	100.20	100.28	100.31	100.37	100.44
2000	6.21	7.62	7.67	7.69	7.75	7.81	67.42	67.48	67.51	67.53	67.61	100.27	100.34	100.38	100.43	100.47
2200	6.36	7.63	7.69	7.70	7.77	7.83	67.48	67.49	67.54	67.59	67.64	100.45	100.49	100.52	100.58	100.63
2400	6.45	7.67	7.73	7.74	7.80	7.86	67.51	67.54	67.59	67.67	67.71	100.47	100.56	100.58	100.64	100.66
2600	6.58	7.70	7.76	7.77	7.83	7.89	67.56	67.64	67.67	67.73	67.78	100.69	100.75	100.76	100.82	100.91
2800	6.74	7.70	7.76	7.77	7.83	7.89	67.61	67.68	67.73	67.78	67.84	100.88	100.94	100.91	100.97	101.06
3000	6.96	7.67	7.72	7.74	7.80	7.86	67.67	67.73	67.73	67.81	67.88	100.97	101.01	101.02	101.09	101.13
3200	7.22	7.61	7.67	7.69	7.75	7.81	67.75	67.77	67.78	67.88	67.94	101.03	101.13	101.07	101.17	101.26
3400	7.43	7.55	7.60	7.63	7.69	7.75	67.74	67.80	67.79	67.88	67.95	101.00	101.08	101.04	101.11	101.17
3600	7.62	7.49	7.55	7.57	7.63	7.69	67.76	67.86	67.86	67.92	67.97	101.07	101.14	101.10	101.19	101.31
3800	7.83	7.45	7.51	7.54	7.60	7.66	67.86	67.93	67.93	67.96	68.11	101.49	101.56	101.53	101.66	101.68
4000	7.99	7.45	7.51	7.54	7.60	7.66	67.93	68.03	68.04	68.09	68.16	101.85	101.96	101.90	102.00	102.06
4200	8.11	7.49	7.55	7.57	7.63	7.69	68.00	68.13	68.07	68.16	68.23	102.14	102.19	102.18	102.24	102.28
4400	8.26	7.53	7.59	7.60	7.67	7.73	68.14	68.20	68.19	68.22	68.31	102.13	102.25	102.18	102.29	102.33
4600	8.43	7.58	7.64	7.64	7.71	7.78	68.21	68.24	68.21	68.31	68.36	102.08	102.19	102.11	102.19	102.26
4800	8.64	7.60	7.67	7.65	7.72	7.79	68.22	68.25	68.21	68.32	68.39	102.07	102.19	102.11	102.16	102.25
5000	8.92	7.61	7.68	7.64	7.72	7.80	68.26	68.30	68.23	68.29	68.40	102.20	102.30	102.21	102.31	102.38
5200	9.18	7.63	7.70	7.66	7.74	7.81	68.35	68.37	68.26	68.39	68.50	102.32	102.41	102.35	102.40	102.48
5400	9.35	7.68	7.76	7.70	7.78	7.86	68.45	68.47	68.39	68.52	68.57	101.86	101.87	101.84	101.87	101.94
5600	9.56	7.75	7.83	7.76	7.85	7.93	68.60	68.66	68.60	68.70	68.76	101.93	101.98	101.93	102.01	102.06
5800	9.85	7.82	7.90	7.83	7.91	8.00	68.67	68.79	68.71	68.77	68.86	102.00	102.02	101.92	102.03	102.09
5900	10.02	7.85	7.93	7.85	7.94	8.03	68.74	68.80	68.74	68.83	68.92	102.01	102.05	101.98	102.05	102.12
6000	10.20	7.87	7.95	7.88	7.96	8.05	68.75	68.89	68.83	68.82	68.92	101.92	102.03	101.89	101.96	102.06

Typical Performance Data @ 0°C

FREQ. (MHz)	I. Loss (dB)	Attenuation relative to I. Loss (dB)												
		@ Attenuation setting (dB)												
		0.25	5	10	20	40	60	80	90	100	105	110	115	120
200	4.07	0.26	5.16	10.19	20.44	40.48	59.59	79.58	89.74	100.48	104.28	108.44	112.74	116.65
250	4.11	0.26	5.15	10.18	20.44	40.44	59.64	79.52	89.67	100.21	104.03	108.18	112.51	116.41
300	4.16	0.26	5.13	10.16	20.43	40.38	59.66	79.43	89.58	99.82	103.74	107.90	112.26	116.18
400	4.30	0.26	5.09	10.11	20.38	40.26	59.60	79.19	89.33	99.29	103.30	107.47	111.83	115.71
500	4.46	0.26	5.04	10.05	20.31	40.14	59.46	78.96	89.09	99.10	103.04	107.24	111.60	115.52
700	4.79	0.25	4.92	9.93	20.15	39.95	59.26	78.77	88.90	99.04	103.17	107.36	111.77	115.73
900	5.06	0.25	4.85	9.88	20.03	39.84	59.31	78.89	89.02	99.25	103.57	107.74	112.16	116.31
1000	5.16	0.25	4.83	9.89	20.00	39.83	59.39	79.01	89.13	99.43	103.79	108.01	112.49	116.57
1200	5.31	0.25	4.85	9.94	20.02	39.86	59.54	79.22	89.34	99.57	104.14	108.38	112.82	117.10
1400	5.42	0.26	4.90	10.03	20.09	39.94	59.60	79.33	89.45	99.87	104.41	108.57	113.02	117.33
1600	5.55	0.26	4.95	10.09	20.16	40.03	59.64	79.41	89.56	100.01	104.53	108.81	113.30	117.66
1800	5.77	0.26	4.99	10.12	20.22	40.07	59.75	79.56	89.73	100.15	104.80	109.17	113.62	118.24
2000	6.03	0.26	5.01	10.12	20.25	40.09	59.86	79.71	89.90	100.17	104.86	109.17	113.58	117.91
2200	6.21	0.26	5.03	10.13	20.27	40.11	59.85	79.73	89.96	100.34	104.96	109.17	113.82	118.06
2400	6.28	0.26	5.06	10.16	20.31	40.16	59.89	79.80	90.04	100.39	105.11	109.36	113.94	118.27
2600	6.41	0.26	5.06	10.17	20.32	40.19	59.96	79.94	90.19	100.59	105.40	109.66	114.37	118.81
2800	6.57	0.26	5.06	10.19	20.31	40.22	60.03	80.03	90.30	100.85	105.52	109.85	114.44	119.14
3000	6.77	0.26	5.04	10.16	20.28	40.22	60.03	80.06	90.32	100.84	105.71	109.97	114.82	119.22
3200	7.01	0.26	5.02	10.14	20.25	40.21	60.04	80.10	90.37	101.00	105.74	110.08	114.68	119.42
3400	7.24	0.26	5.04	10.14	20.25	40.23	60.11	80.18	90.43	100.96	105.66	109.85	114.31	118.56
3600	7.44	0.26	5.08	10.14	20.30	40.30	60.12	80.20	90.44	100.90	105.61	109.69	114.08	118.13
3800	7.64	0.26	5.16	10.16	20.37	40.36	60.18	80.32	90.64	101.40	106.31	110.72	115.87	121.22
4000	7.79	0.27	5.25	10.21	20.47	40.46	60.27	80.44	90.80	101.79	106.83	111.55	117.26	123.74
4200	7.91	0.27	5.35	10.28	20.59	40.55	60.31	80.49	90.95	102.11	107.18	111.92	117.87	124.07
4400	8.06	0.28	5.43	10.34	20.72	40.65	60.38	80.61	91.10	102.23	107.10	111.71	117.06	122.70
4600	8.22	0.29	5.50	10.38	20.83	40.72	60.42	80.65	91.13	102.04	106.96	111.40	116.63	121.62
4800	8.42	0.30	5.54	10.38	20.89	40.78	60.44	80.69	91.23	102.01	107.05	111.44	117.07	122.27
5000	8.64	0.31	5.55	10.38	20.92	40.81	60.50	80.75	91.31	102.31	107.19	111.85	117.28	122.76
5200	8.88	0.31	5.54	10.40	20.97	40.83	60.57	80.85	91.36	102.35	107.21	111.46	116.63	121.00
5400	9.10	0.31	5.56	10.46	21.04	40.91	60.72	80.97	91.35	101.84	106.64	110.63	115.34	119.39
5600	9.33	0.32	5.59	10.57	21.11	41.01	60.89	81.12	91.45	101.99	106.98	110.91	115.76	120.01
5800	9.60	0.33	5.65	10.69	21.16	41.09	61.08	81.28	91.52	101.98	107.22	111.31	116.09	120.98
5900	9.77	0.34	5.69	10.75	21.17	41.11	61.13	81.32	91.54	102.03	107.25	111.33	116.42	121.22
6000	9.96	0.35	5.74	10.79	21.15	41.12	61.16	81.34	91.52	101.96	107.15	111.20	116.26	121.13

FREQ. (MHz)	I. Loss (dB)	Attenuation relative to I. Loss Fine resolution (0.05 dB)														
		@ Attenuation setting (dB)														
		7.40	7.45	7.50	7.55	7.60	67.40	67.45	67.50	67.55	67.60	100.40	100.45	100.50	100.55	100.60
200	4.07	7.58	7.63	7.66	7.72	7.77	67.66	67.72	67.79	67.83	67.87	100.85	100.88	100.99	101.02	101.05
250	4.11	7.57	7.63	7.66	7.71	7.76	67.65	67.70	67.76	67.80	67.84	100.58	100.62	100.73	100.74	100.78
300	4.16	7.56	7.61	7.65	7.70	7.75	67.61	67.65	67.72	67.76	67.81	100.18	100.24	100.33	100.36	100.41
400	4.30	7.52	7.57	7.60	7.66	7.71	67.47	67.54	67.61	67.66	67.69	99.67	99.72	99.81	99.85	99.89
500	4.46	7.47	7.52	7.55	7.61	7.66	67.37	67.44	67.49	67.56	67.60	99.46	99.48	99.57	99.61	99.67
700	4.79	7.39	7.43	7.46	7.52	7.58	67.24	67.29	67.37	67.39	67.47	99.45	99.50	99.58	99.63	99.66
900	5.06	7.36	7.41	7.43	7.49	7.55	67.23	67.26	67.31	67.36	67.40	99.69	99.73	99.80	99.86	99.92
1000	5.16	7.37	7.42	7.44	7.51	7.56	67.22	67.28	67.33	67.38	67.40	99.82	99.87	99.95	100.00	100.04
1200	5.31	7.44	7.49	7.51	7.57	7.63	67.31	67.36	67.37	67.44	67.50	100.03	100.10	100.14	100.19	100.26
1400	5.42	7.53	7.58	7.61	7.67	7.72	67.43	67.47	67.51	67.56	67.64	100.30	100.35	100.39	100.44	100.49
1600	5.55	7.59	7.64	7.66	7.73	7.78	67.50	67.57	67.61	67.67	67.73	100.52	100.56	100.58	100.67	100.73
1800	5.77	7.61	7.66	7.68	7.75	7.80	67.57	67.63	67.63	67.72	67.72	100.57	100.63	100.67	100.73	100.79
2000	6.03	7.62	7.67	7.68	7.75	7.81	67.60	67.69	67.66	67.72	67.78	100.64	100.69	100.72	100.77	100.83
2200	6.21	7.63	7.69	7.69	7.76	7.82	67.66	67.66	67.69	67.77	67.82	100.81	100.84	100.85	100.92	101.00
2400	6.28	7.67	7.73	7.72	7.79	7.85	67.67	67.75	67.74	67.79	67.84	100.81	100.89	100.90	100.95	101.03
2600	6.41	7.70	7.76	7.75	7.82	7.89	67.76	67.81	67.80	67.87	67.93	101.06	101.15	101.15	101.19	101.24
2800	6.57	7.70	7.76	7.75	7.82	7.88	67.81	67.89	67.87	67.91	68.00	101.22	101.32	101.24	101.37	101.41
3000	6.77	7.67	7.73	7.73	7.79	7.85	67.84	67.93	67.90	67.97	68.00	101.35	101.42	101.41	101.49	101.55
3200	7.01	7.62	7.68	7.68	7.74	7.80	67.90	67.96	67.94	68.04	68.08	101.45	101.54	101.50	101.58	101.69
3400	7.24	7.56	7.61	7.62	7.68	7.74	67.93	68.02	68.02	68.07	68.17	101.44	101.52	101.47	101.54	101.62
3600	7.44	7.51	7.56	7.58	7.64	7.70	67.97	68.11	68.13	68.12	68.22	101.46	101.51	101.43	101.54	101.61
3800	7.64	7.47	7.52	7.54	7.60	7.66	68.09	68.15	68.12	68.20	68.26	101.86	101.96	101.87	102.00	102.05
4000	7.79	7.45	7.51	7.52	7.59	7.65	68.14	68.19	68.19	68.26	68.36	102.26	102.40	102.30	102.37	102.47
4200	7.91	7.49	7.55	7.56	7.63	7.69	68.24	68.30	68.29	68.36	68.45	102.63	102.65	102.59	102.72	102.79
4400	8.06	7.53	7.59	7.59	7.66	7.73	68.31	68.40	68.31	68.42	68.47	102.65	102.73	102.65	102.77	102.83
4600	8.22	7.57	7.64	7.62	7.69	7.76	68.38	68.42	68.36	68.45	68.56	102.54	102.62	102.51	102.60	102.66
4800	8.42	7.59	7.66	7.63	7.71	7.78	68.39	68.48	68.42	68.48	68.55	102.58	102.62	102.57	102.61	102.70
5000	8.64	7.60	7.67	7.62	7.70	7.78	68.47	68.50	68.40	68.53	68.58	102.78	102.83	102.79	102.84	102.94
5200	8.88	7.62	7.70	7.63	7.72	7.79	68.49	68.60	68.49	68.58	68.67	102.92	102.94	102.83	102.92	103.02
5400	9.10	7.67	7.74	7.67	7.76	7.84	68.56	68.70	68.57	68.70	68.75	102.25	102.31	102.23	102.27	102.39
5600	9.33	7.74	7.82	7.73	7.82	7.90	68.78	68.88	68.74	68.79	68.91	102.42	102.53	102.40	102.46	102.57
5800	9.60	7.82	7.90	7.81	7.90	7.98	68.90	68.98	68.89	69.02	69.06	102.37	102.45	102.39	102.47	102.60
5900	9.77	7.86	7.94	7.85	7.94	8.02	68.96	69.06	68.91	69.06	69.13	102.46	102.56	102.41	102.52	102.62
6000	9.96	7.89	7.97	7.88	7.97	8.06	68.96	69.08	68.96	69.04	69.11	102.45	102.49	102.46	102.52	102.58

Typical Performance Data @ +50°C

FREQ. (MHz)	I. Loss (dB)	Attenuation relative to I. Loss (dB)												
		@ Attenuation setting (dB)												
		0.25	5	10	20	40	60	80	90	100	105	110	115	120
200	4.25	0.27	5.11	10.15	20.32	40.21	59.18	79.06	89.13	99.81	103.54	107.66	112.05	115.93
250	4.30	0.26	5.09	10.13	20.31	40.16	59.22	79.00	89.06	99.54	103.30	107.43	111.78	115.60
300	4.36	0.26	5.07	10.10	20.29	40.09	59.23	78.90	88.94	99.11	103.03	107.14	111.51	115.21
400	4.51	0.26	5.03	10.04	20.23	39.96	59.16	78.65	88.69	98.61	102.55	106.65	111.00	114.71
500	4.68	0.26	4.97	9.98	20.15	39.83	59.01	78.42	88.45	98.36	102.32	106.46	110.77	114.55
700	5.01	0.25	4.87	9.87	20.00	39.65	58.80	78.22	88.28	98.40	102.43	106.52	110.80	114.85
900	5.29	0.25	4.81	9.82	19.89	39.56	58.85	78.35	88.38	98.62	102.79	106.93	111.32	115.47
1000	5.40	0.26	4.81	9.83	19.87	39.56	58.94	78.48	88.52	98.71	103.06	107.23	111.61	115.69
1200	5.54	0.26	4.84	9.90	19.90	39.61	59.10	78.69	88.72	98.96	103.37	107.56	111.85	116.28
1400	5.65	0.26	4.90	9.99	19.98	39.71	59.18	78.82	88.85	99.17	103.63	107.84	112.19	116.57
1600	5.78	0.27	4.96	10.06	20.06	39.81	59.22	78.90	88.94	99.39	103.79	108.03	112.41	116.88
1800	6.00	0.27	4.99	10.09	20.10	39.85	59.34	79.05	89.11	99.45	104.00	108.22	112.64	117.08
2000	6.26	0.26	5.00	10.10	20.12	39.87	59.46	79.21	89.29	99.55	104.16	108.43	112.82	117.07
2200	6.41	0.26	5.00	10.11	20.14	39.89	59.44	79.23	89.33	99.65	104.25	108.52	112.83	117.15
2400	6.50	0.26	5.02	10.13	20.16	39.93	59.48	79.30	89.42	99.72	104.40	108.59	113.08	117.64
2600	6.63	0.26	5.02	10.16	20.18	39.97	59.59	79.44	89.59	99.97	104.66	108.97	113.52	118.20
2800	6.81	0.26	5.01	10.15	20.17	39.98	59.64	79.53	89.69	100.09	104.80	109.05	113.69	118.29
3000	7.05	0.26	4.99	10.11	20.13	39.95	59.61	79.53	89.69	100.18	104.86	109.19	113.90	118.36
3200	7.29	0.26	4.98	10.08	20.11	39.94	59.61	79.54	89.69	100.18	104.94	109.05	113.70	117.83
3400	7.50	0.26	5.00	10.06	20.11	39.96	59.65	79.60	89.73	100.17	104.89	109.12	113.44	117.41
3600	7.71	0.27	5.04	10.06	20.15	39.99	59.64	79.61	89.78	100.29	105.03	109.31	113.81	118.39
3800	7.89	0.27	5.10	10.08	20.22	40.06	59.68	79.69	89.93	100.66	105.53	109.91	115.13	120.51
4000	8.05	0.27	5.19	10.12	20.32	40.14	59.75	79.79	90.10	101.07	105.81	110.42	116.07	121.88
4200	8.21	0.28	5.29	10.18	20.44	40.24	59.80	79.86	90.26	101.19	106.11	110.87	116.66	122.45
4400	8.36	0.29	5.38	10.24	20.56	40.33	59.89	79.99	90.40	101.35	106.13	110.76	116.21	121.19
4600	8.54	0.30	5.46	10.28	20.65	40.39	59.94	80.06	90.45	101.28	105.93	110.34	115.36	120.08
4800	8.75	0.31	5.48	10.30	20.70	40.42	59.95	80.08	90.50	101.23	105.99	110.43	115.60	120.60
5000	8.99	0.31	5.47	10.30	20.74	40.45	59.99	80.14	90.60	101.49	106.31	110.86	116.47	121.47
5200	9.23	0.31	5.46	10.32	20.77	40.49	60.06	80.22	90.64	101.48	105.97	110.12	114.89	118.90
5400	9.43	0.31	5.47	10.38	20.82	40.57	60.22	80.36	90.65	101.00	105.86	110.00	114.60	119.20
5600	9.64	0.32	5.50	10.47	20.88	40.66	60.38	80.51	90.74	101.13	106.04	110.05	114.81	119.51
5800	9.91	0.33	5.56	10.57	20.91	40.72	60.54	80.63	90.83	101.10	106.21	110.48	115.42	119.92
5900	10.08	0.34	5.61	10.63	20.91	40.73	60.58	80.64	90.81	101.36	106.23	110.43	115.41	120.11
6000	10.27	0.35	5.65	10.67	20.89	40.72	60.60	80.64	90.77	101.23	106.18	110.31	115.30	120.26

FREQ. (MHz)	I. Loss (dB)	Attenuation relative to I. Loss Fine resolution (0.05 dB)														
		@ Attenuation setting (dB)														
		7.40	7.45	7.50	7.55	7.60	67.40	67.45	67.50	67.55	67.60	100.40	100.45	100.50	100.55	100.60
200	4.25	7.57	7.62	7.67	7.72	7.77	67.30	67.31	67.42	67.45	67.51	100.20	100.22	100.32	100.36	100.40
250	4.30	7.55	7.60	7.65	7.70	7.75	67.24	67.27	67.36	67.40	67.45	99.91	99.93	100.04	100.08	100.11
300	4.36	7.53	7.58	7.63	7.68	7.73	67.16	67.20	67.30	67.34	67.38	99.51	99.53	99.64	99.66	99.71
400	4.51	7.47	7.52	7.57	7.62	7.67	67.04	67.08	67.17	67.19	67.25	99.00	99.03	99.13	99.15	99.21
500	4.68	7.42	7.46	7.52	7.57	7.61	66.93	66.96	67.05	67.09	67.14	98.73	98.79	98.87	98.92	98.97
700	5.01	7.33	7.38	7.43	7.48	7.53	66.78	66.81	66.91	66.95	67.00	98.76	98.79	98.89	98.90	98.98
900	5.29	7.31	7.36	7.41	7.46	7.51	66.73	66.76	66.87	66.90	66.94	98.99	99.03	99.12	99.15	99.21
1000	5.40	7.33	7.37	7.42	7.47	7.53	66.76	66.80	66.88	66.92	66.97	99.11	99.17	99.25	99.30	99.33
1200	5.54	7.40	7.44	7.50	7.55	7.60	66.81	66.88	66.94	66.99	67.05	99.33	99.38	99.47	99.51	99.55
1400	5.65	7.49	7.54	7.59	7.64	7.69	66.96	67.00	67.06	67.13	67.15	99.57	99.63	99.69	99.77	99.78
1600	5.78	7.56	7.61	7.66	7.71	7.76	67.10	67.13	67.16	67.24	67.27	99.81	99.86	99.92	99.95	100.02
1800	6.00	7.59	7.64	7.68	7.74	7.79	67.18	67.20	67.23	67.30	67.36	99.85	99.95	99.97	100.02	100.08
2000	6.26	7.59	7.64	7.68	7.74	7.79	67.16	67.22	67.26	67.32	67.34	99.97	100.00	100.08	100.11	100.18
2200	6.41	7.60	7.66	7.69	7.75	7.80	67.20	67.26	67.30	67.36	67.38	100.09	100.18	100.19	100.25	100.29
2400	6.50	7.64	7.70	7.72	7.78	7.84	67.22	67.29	67.34	67.39	67.47	100.14	100.20	100.23	100.31	100.37
2600	6.63	7.67	7.73	7.75	7.81	7.87	67.34	67.38	67.43	67.50	67.52	100.38	100.42	100.45	100.54	100.58
2800	6.81	7.67	7.72	7.75	7.81	7.86	67.36	67.42	67.42	67.51	67.53	100.54	100.57	100.58	100.62	100.71
3000	7.05	7.63	7.68	7.71	7.77	7.82	67.40	67.46	67.47	67.57	67.60	100.61	100.67	100.68	100.75	100.80
3200	7.29	7.56	7.62	7.65	7.71	7.76	67.42	67.46	67.48	67.55	67.64	100.67	100.72	100.77	100.79	100.87
3400	7.50	7.49	7.54	7.59	7.64	7.69	67.46	67.48	67.53	67.58	67.64	100.64	100.70	100.71	100.77	100.85
3600	7.71	7.43	7.48	7.53	7.58	7.63	67.48	67.56	67.54	67.65	67.65	100.78	100.86	100.83	100.89	100.97
3800	7.89	7.40	7.45	7.49	7.55	7.60	67.56	67.59	67.60	67.72	67.79	101.10	101.17	101.15	101.18	101.27
4000	8.05	7.40	7.45	7.50	7.55	7.61	67.62	67.71	67.71	67.78	67.85	101.47	101.55	101.54	101.64	101.69
4200	8.21	7.43	7.49	7.53	7.59	7.64	67.71	67.81	67.82	67.84	67.96	101.74	101.77	101.76	101.83	101.89
4400	8.36	7.48	7.54	7.57	7.63	7.69	67.79	67.86	67.84	67.92	68.01	101.79	101.85	101.86	101.90	101.96
4600	8.54	7.53	7.59	7.61	7.67	7.73	67.90	67.91	67.86	67.99	68.06	101.73	101.80	101.74	101.83	101.90
4800	8.75	7.55	7.61	7.61	7.68	7.74	67.90	68.02	67.89	68.01	68.08	101.71	101.79	101.75	101.81	101.94
5000	8.99	7.55	7.62	7.61	7.68	7.75	67.90	68.02	67.95	67.97	68.10	101.81	101.95	101.87	101.95	102.04
5200	9.23	7.58	7.64	7.62	7.69	7.76	68.00	68.07	68.03	68.10	68.17	101.93	101.97	101.90	102.01	102.04
5400	9.43	7.63	7.70	7.66	7.74	7.81	68.12	68.21	68.14	68.21	68.26	101.41	101.52	101.45	101.52	101.59
5600	9.64	7.69	7.77	7.73	7.80	7.88	68.30	68.34	68.28	68.36	68.42	101.58	101.59	101.54	101.65	101.75
5800	9.91	7.75	7.83	7.78	7.86	7.94	68.37	68.47	68.40	68.48	68.60	101.56	101.67	101.64	101.66	101.79
5900	10.08	7.78	7.86	7.81	7.89	7.97	68.46	68.48	68.43	68.49	68.56	101.68	101.67	101.64	101.68	101.76
6000	10.27	7.80	7.88	7.82	7.91	7.99	68.41	68.49	68.48	68.52	68.57	101.58	101.55	101.62	101.65	101.63

Typical Performance Data @ +25°C

FREQ. (MHz)	VSWR In (:1)													
	@ Attenuation setting (dB)													
	0	0.25	5	10	20	40	60	80	90	100	105	110	115	120
200	1.72	1.70	1.30	1.24	1.11	1.24	1.11	1.11	1.09	1.11	1.11	1.11	1.09	1.09
250	1.64	1.61	1.25	1.22	1.08	1.23	1.09	1.10	1.07	1.10	1.10	1.10	1.07	1.07
300	1.56	1.54	1.22	1.20	1.07	1.23	1.08	1.09	1.06	1.09	1.09	1.09	1.06	1.06
400	1.43	1.41	1.19	1.19	1.07	1.23	1.08	1.09	1.05	1.09	1.09	1.09	1.05	1.05
500	1.29	1.28	1.18	1.20	1.07	1.23	1.07	1.08	1.04	1.08	1.08	1.08	1.04	1.04
700	1.04	1.04	1.22	1.22	1.09	1.23	1.07	1.08	1.03	1.08	1.08	1.08	1.03	1.03
900	1.14	1.14	1.29	1.26	1.10	1.23	1.06	1.08	1.03	1.08	1.08	1.08	1.03	1.03
1000	1.23	1.23	1.33	1.29	1.10	1.23	1.06	1.08	1.03	1.08	1.08	1.08	1.03	1.03
1200	1.38	1.37	1.38	1.32	1.09	1.21	1.05	1.07	1.03	1.07	1.07	1.07	1.03	1.03
1400	1.45	1.44	1.39	1.32	1.08	1.20	1.05	1.07	1.04	1.07	1.07	1.07	1.04	1.04
1600	1.44	1.44	1.36	1.31	1.06	1.18	1.04	1.06	1.04	1.06	1.06	1.06	1.04	1.04
1800	1.41	1.41	1.32	1.28	1.05	1.17	1.04	1.06	1.04	1.06	1.06	1.06	1.04	1.04
2000	1.41	1.41	1.30	1.26	1.04	1.16	1.03	1.05	1.04	1.05	1.05	1.05	1.04	1.04
2200	1.46	1.46	1.32	1.27	1.03	1.15	1.02	1.04	1.03	1.04	1.04	1.04	1.03	1.03
2400	1.52	1.52	1.34	1.28	1.04	1.14	1.01	1.03	1.03	1.03	1.03	1.03	1.03	1.03
2600	1.55	1.54	1.36	1.29	1.04	1.14	1.00	1.02	1.03	1.02	1.02	1.02	1.03	1.03
2800	1.52	1.51	1.36	1.29	1.06	1.14	1.01	1.02	1.03	1.02	1.02	1.02	1.03	1.03
3000	1.43	1.42	1.34	1.28	1.07	1.14	1.02	1.02	1.03	1.02	1.02	1.02	1.03	1.03
3200	1.31	1.30	1.30	1.25	1.08	1.13	1.02	1.02	1.03	1.01	1.01	1.01	1.03	1.03
3400	1.18	1.17	1.24	1.21	1.09	1.13	1.02	1.02	1.03	1.02	1.02	1.02	1.03	1.03
3600	1.08	1.07	1.18	1.18	1.09	1.13	1.02	1.02	1.03	1.02	1.02	1.02	1.03	1.03
3800	1.06	1.06	1.11	1.15	1.07	1.12	1.02	1.02	1.03	1.02	1.02	1.02	1.03	1.03
4000	1.12	1.12	1.04	1.13	1.05	1.12	1.02	1.03	1.02	1.03	1.03	1.03	1.02	1.02
4200	1.18	1.17	1.06	1.13	1.03	1.13	1.02	1.04	1.01	1.04	1.04	1.04	1.01	1.01
4400	1.18	1.17	1.13	1.14	1.03	1.13	1.02	1.04	1.01	1.04	1.04	1.04	1.01	1.01
4600	1.17	1.16	1.21	1.17	1.05	1.15	1.03	1.05	1.02	1.05	1.05	1.05	1.02	1.02
4800	1.17	1.16	1.29	1.21	1.08	1.17	1.04	1.07	1.03	1.07	1.07	1.07	1.03	1.03
5000	1.19	1.19	1.34	1.24	1.09	1.19	1.05	1.08	1.04	1.08	1.08	1.08	1.04	1.04
5200	1.22	1.22	1.35	1.25	1.09	1.20	1.07	1.10	1.07	1.10	1.10	1.10	1.07	1.07
5400	1.20	1.20	1.32	1.23	1.06	1.20	1.09	1.13	1.09	1.13	1.13	1.13	1.09	1.09
5600	1.14	1.14	1.26	1.18	1.03	1.20	1.11	1.15	1.12	1.15	1.15	1.15	1.12	1.12
5800	1.09	1.09	1.22	1.12	1.05	1.19	1.13	1.18	1.15	1.18	1.18	1.18	1.15	1.15
5900	1.09	1.09	1.23	1.11	1.08	1.18	1.14	1.19	1.16	1.19	1.19	1.19	1.16	1.16
6000	1.11	1.12	1.26	1.11	1.12	1.18	1.16	1.21	1.18	1.21	1.21	1.21	1.18	1.18

FREQ. (MHz)	VSWR Out (:1)													
	@ Attenuation setting (dB)													
	0	0.25	5	10	20	40	60	80	90	100	105	110	115	120
200	1.72	1.71	1.57	1.21	1.36	1.13	1.07	1.07	1.18	1.12	1.07	1.07	1.12	1.07
250	1.64	1.63	1.53	1.19	1.35	1.12	1.05	1.05	1.17	1.10	1.05	1.05	1.10	1.05
300	1.58	1.57	1.50	1.17	1.34	1.11	1.04	1.04	1.17	1.09	1.04	1.04	1.09	1.04
400	1.46	1.46	1.44	1.15	1.33	1.10	1.02	1.03	1.17	1.09	1.02	1.02	1.09	1.02
500	1.33	1.34	1.38	1.13	1.32	1.10	1.01	1.02	1.17	1.09	1.01	1.01	1.09	1.01
700	1.15	1.16	1.28	1.09	1.30	1.10	1.02	1.03	1.16	1.09	1.03	1.03	1.09	1.03
900	1.16	1.17	1.24	1.06	1.29	1.09	1.04	1.04	1.16	1.09	1.04	1.04	1.09	1.04
1000	1.24	1.23	1.24	1.06	1.28	1.09	1.05	1.04	1.16	1.09	1.05	1.05	1.09	1.05
1200	1.37	1.36	1.26	1.06	1.27	1.09	1.06	1.05	1.15	1.08	1.06	1.06	1.08	1.06
1400	1.42	1.40	1.26	1.06	1.25	1.08	1.07	1.06	1.14	1.08	1.08	1.08	1.08	1.08
1600	1.37	1.36	1.24	1.06	1.23	1.07	1.09	1.07	1.13	1.07	1.09	1.09	1.07	1.09
1800	1.26	1.25	1.20	1.05	1.21	1.07	1.10	1.08	1.12	1.07	1.10	1.10	1.07	1.10
2000	1.15	1.15	1.17	1.04	1.19	1.06	1.10	1.09	1.10	1.06	1.11	1.11	1.06	1.11
2200	1.10	1.11	1.16	1.02	1.18	1.05	1.10	1.08	1.09	1.05	1.10	1.10	1.05	1.10
2400	1.11	1.12	1.17	1.01	1.17	1.03	1.09	1.07	1.08	1.03	1.10	1.10	1.03	1.10
2600	1.13	1.14	1.17	1.02	1.16	1.02	1.10	1.07	1.07	1.02	1.10	1.10	1.02	1.10
2800	1.14	1.15	1.17	1.02	1.16	1.01	1.09	1.07	1.06	1.01	1.09	1.09	1.01	1.09
3000	1.14	1.14	1.18	1.02	1.16	1.03	1.08	1.06	1.07	1.02	1.08	1.08	1.02	1.08
3200	1.14	1.14	1.18	1.01	1.17	1.04	1.07	1.05	1.07	1.03	1.07	1.07	1.03	1.07
3400	1.18	1.17	1.18	1.02	1.17	1.04	1.06	1.04	1.08	1.04	1.06	1.06	1.04	1.06
3600	1.25	1.24	1.19	1.04	1.17	1.05	1.05	1.03	1.09	1.05	1.05	1.05	1.05	1.05
3800	1.32	1.30	1.22	1.05	1.18	1.06	1.04	1.03	1.09	1.05	1.04	1.04	1.05	1.04
4000	1.36	1.33	1.23	1.05	1.19	1.08	1.04	1.04	1.11	1.07	1.04	1.04	1.07	1.04
4200	1.34	1.31	1.24	1.07	1.20	1.09	1.06	1.07	1.13	1.08	1.06	1.06	1.08	1.06
4400	1.25	1.23	1.22	1.08	1.21	1.11	1.09	1.11	1.14	1.10	1.09	1.09	1.10	1.09
4600	1.12	1.11	1.19	1.10	1.19	1.11	1.13	1.14	1.15	1.11	1.13	1.13	1.11	1.13
4800	1.05	1.07	1.17	1.11	1.19	1.12	1.16	1.17	1.17	1.12	1.16	1.16	1.12	1.16
5000	1.11	1.13	1.16	1.13	1.19	1.14	1.20	1.22	1.19	1.15	1.20	1.20	1.15	1.20
5200	1.16	1.16	1.12	1.16	1.18	1.17	1.25	1.27	1.23	1.18	1.25	1.25	1.18	1.25
5400	1.15	1.14	1.05	1.18	1.17	1.19	1.29	1.31	1.26	1.21	1.30	1.30	1.21	1.30
5600	1.10	1.08	1.05	1.23	1.16	1.23	1.34	1.36	1.29	1.25	1.34	1.34	1.25	1.34
5800	1.09	1.08	1.16	1.29	1.17	1.26	1.38	1.40	1.32	1.28	1.38	1.38	1.28	1.38
5900	1.12	1.12	1.23	1.32	1.18	1.28	1.40	1.42	1.33	1.29	1.40	1.40	1.29	1.40
6000	1.16	1.18	1.29	1.36	1.19	1.30	1.42	1.44	1.34	1.31	1.42	1.42	1.31	1.42

Typical Performance Curves *

*at +25°C unless noted otherwise

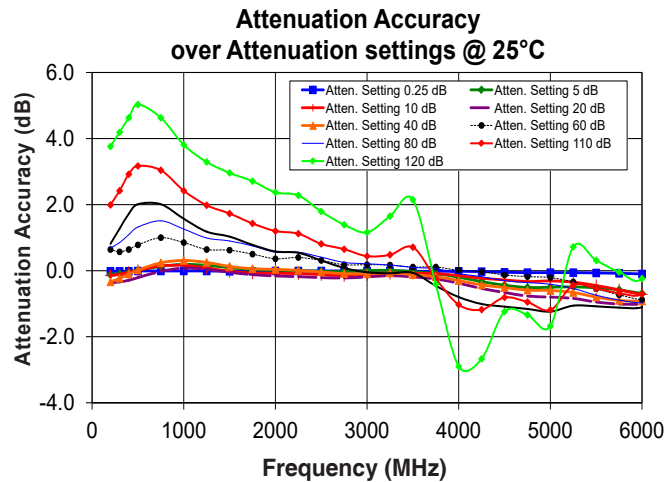
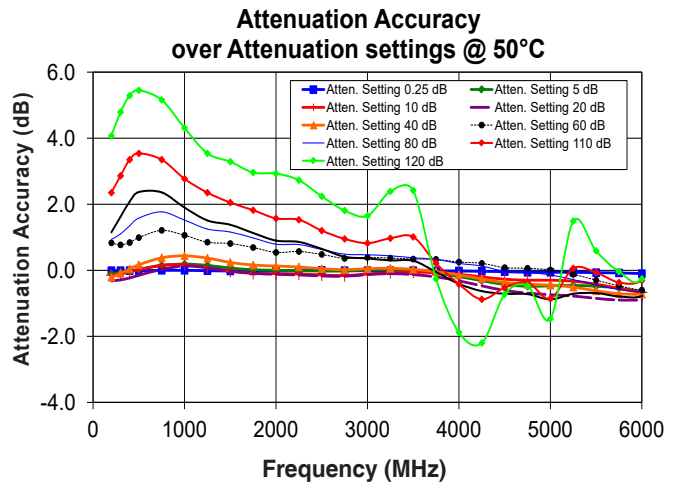
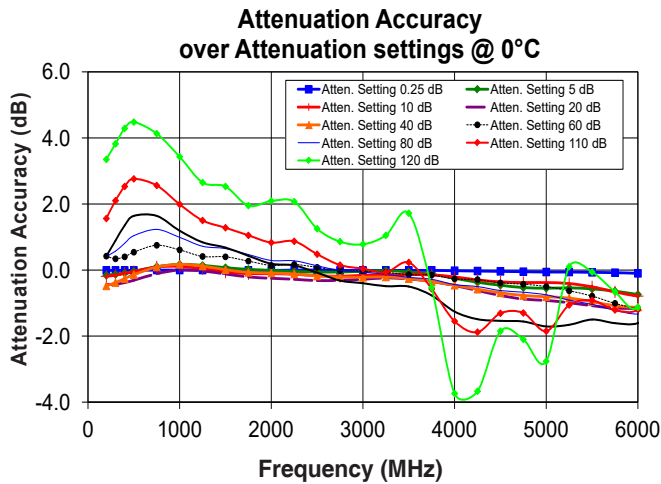
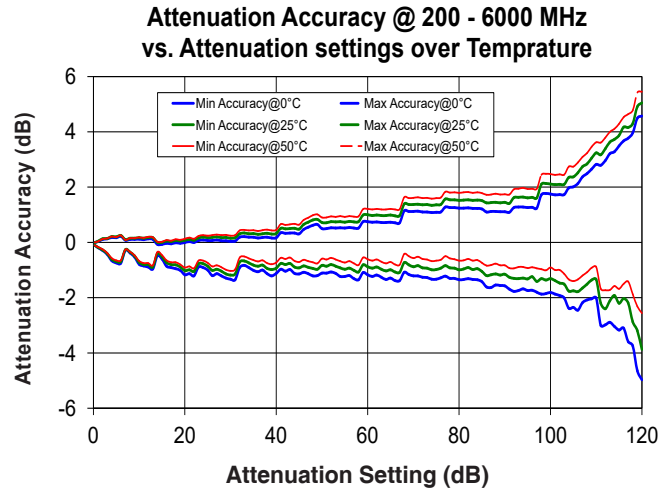
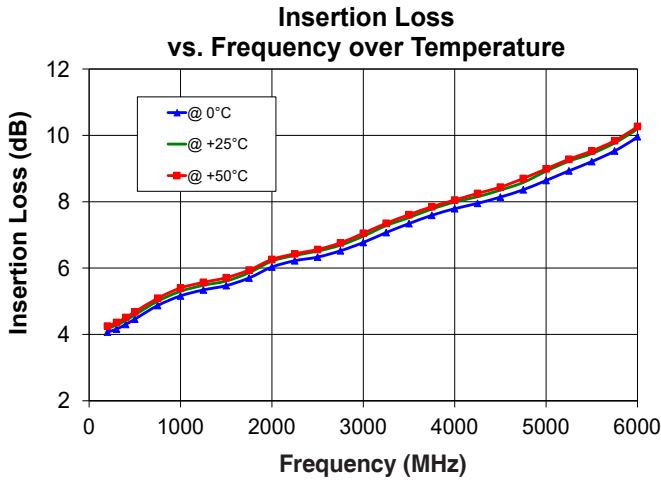

Typical Performance Curves (Continued) *

*at +25°C unless noted otherwise

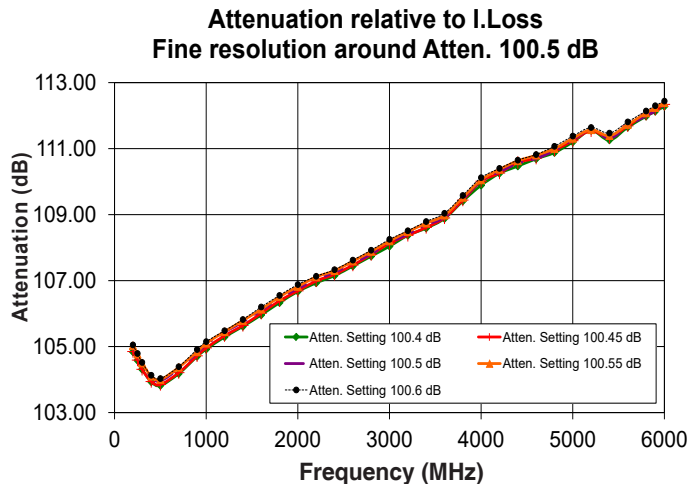
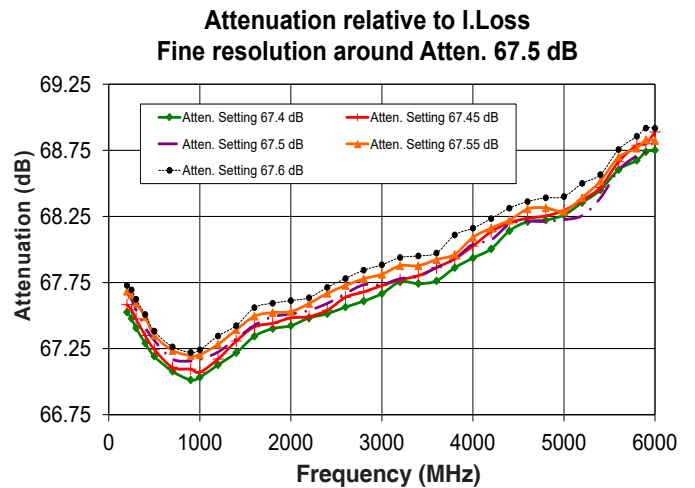
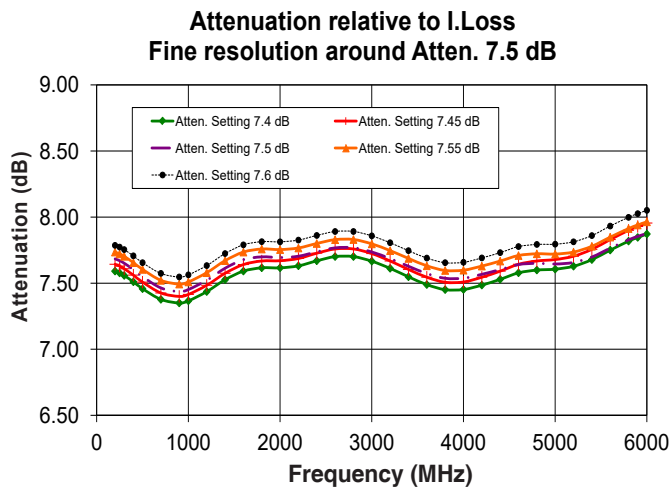
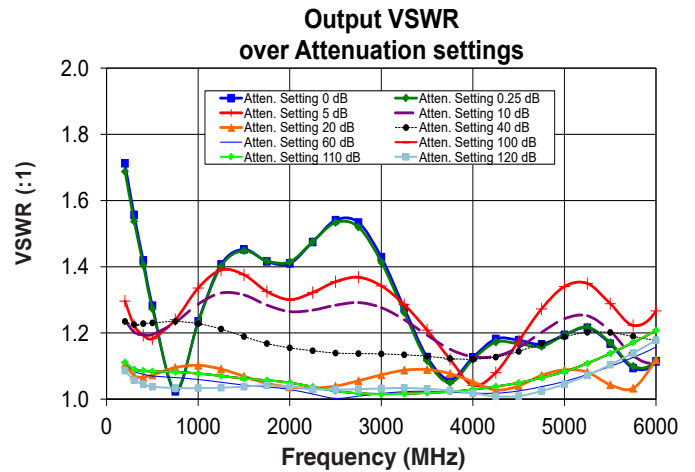
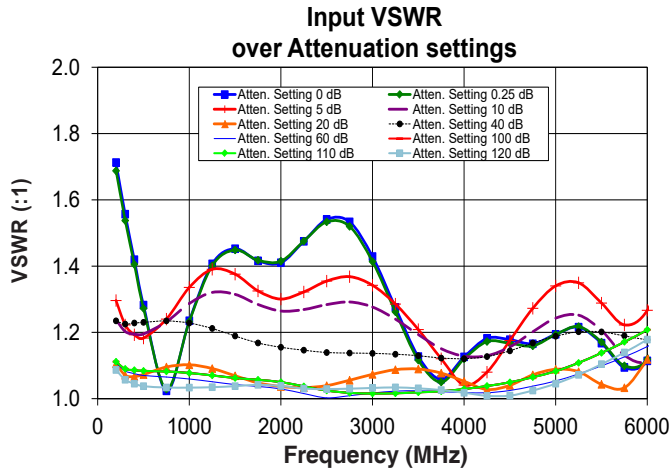

Typical Transition times @ +25°C

Transition 20 dB to 0 dB,
tested using Oscilloscope

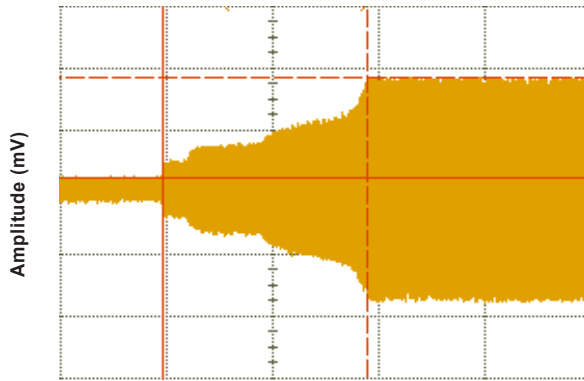

Rise time at transition 20 to 0 dB:
 Δt : 192.7 ns ; ΔV : 161.8 mV
 Scale 100 ns/dev ; 100 mV/dev

Transition 0 dB to 20 dB,
tested using Oscilloscope

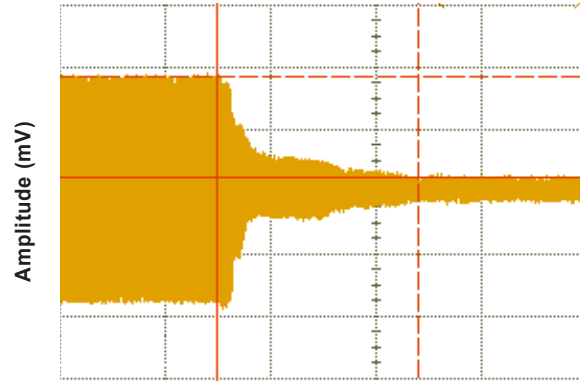

Fall time at transition 0 to 20 dB:
 Δt : 190.9 ns ; ΔV : 161.8 mV
 Scale 100 ns/dev ; 100 mV/dev

Transition 20.2 dB to 20 dB,
tested using Spectrum Analyzer

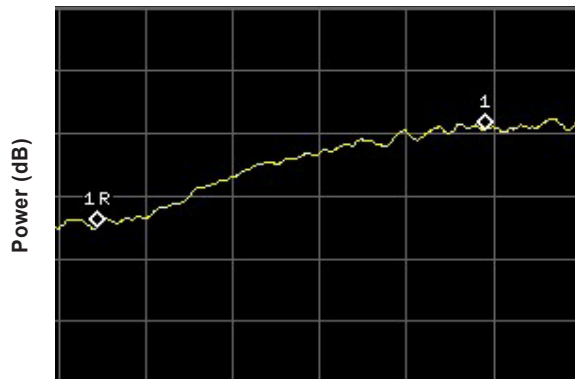

Fall time at transition 20.2 to 20 dB:
 Δt : 4.45 μ s ; ΔP : 0.15 dB
 Scale 1 μ s/dev ; 0.1 dB/dev

Transition 20 dB to 20.2 dB,
tested using Spectrum Analyzer

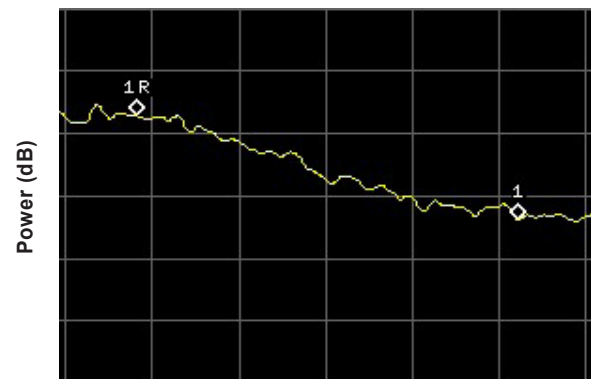

Fall time at transition 20 to 20.2 dB:
 Δt : 4.4 μ s ; ΔP : 0.17 dB
 Scale 1 μ s/dev ; 0.1 dB/dev

Note: All transition time tests performed with input signal of 501 MHz, 0 dBm.

Software & Documentation Download:

- Mini-Circuits' full software and support package including user guide, Windows GUI, DLL files, programming manual and examples can be downloaded free of charge from <http://www.minicircuits.com/softwaredownload/patt.html>
- Please contact testsolutions@minicircuits.com for support

Minimum System Requirements

Parameter	Requirements	
Interface	USB HID or HTTP Get/Post or Telnet protocols or SSH protocols	
System requirements	GUI:	Windows 32 & 64 bit systems from Windows 98 up to Windows 10
	USB API (ActiveX & .Net)	Windows 32 & 64 bit systems with ActiveX or .Net support from Windows 98 up to Windows 10
	USB direct programming support	Linux, Windows systems from Windows 98 up to Windows 10
	HTTP, Telnet or SSH	Any computer with a network port and Ethernet-TCP/IP (HTTP, Telnet or SSH protocols) support
Hardware	Pentium® II or higher, RAM 256 MB	

Graphical User Interface (GUI) for Windows

Key Features:

- Manual attenuation setting
- Sweep and Hop attenuation sequences directed from the PC, or entire sequence loaded into RCDAT.
- Attenuator address configuration and Firmware upgrade
- Attenuation at power up may be set to selected attenuation level or last attenuation state recorded.
- USB, HTTP, Telnet or SSH control of RCDAT
- Setting Ethernet configuration including SSH login and password

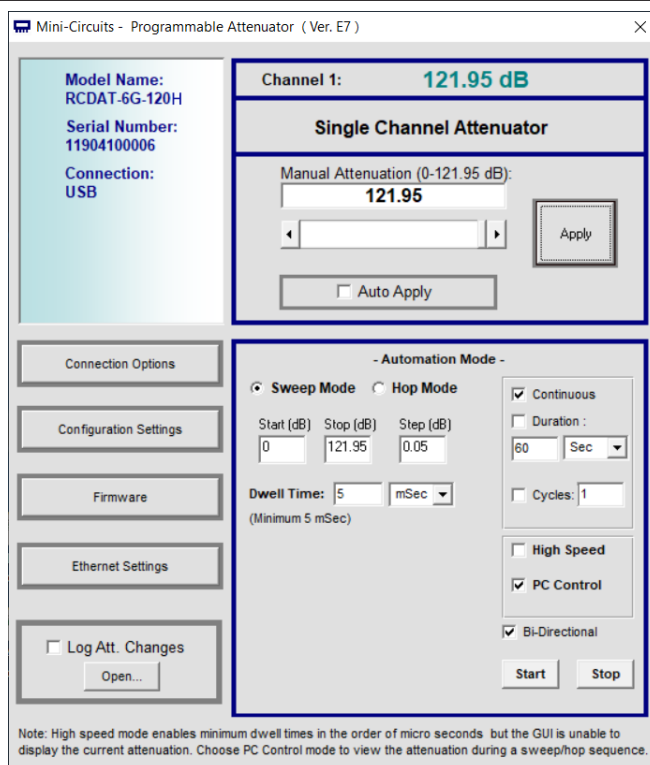

Application Programming Interface (API)

Programming manual: https://www.minicircuits.com/softwaredownload/Prog_Manual-6-Programmable_Attenuator.pdf

Windows Support:

- API DLL files exposing the full switch functionality
 - ActiveX COM DLL file for creation of 32-bit programs
 - .Net library DLL file for creation of 32 / 64-bit programs
- Supported by most common programming environments (refer to application note [AN-49-001](#) for summary of tested environments)

Linux Support:

- Full attenuator control in a Linux environment is achieved by way of USB interrupt commands.

Ordering Information

Model	Description
RCDAT-6G-120H	USB/Ethernet Programmable Attenuator

Included Accessories	Part No.	Description
	MUSB-CBL-3+	3.3 ft (1.0 m) USB Cable: USB type A(Male) to USB type Mini-B(Male)

Optional Accessories	Description
USB-AC/DC-5 ^{9, 10}	AC/DC 5V _{DC} Power Adapter with US, EU, IL, UK, AUS, and China power plugs
MUSB-CBL-3+ (spare)	3.3 ft (1.0 m) USB Cable: USB type A(Male) to USB type Mini-B(Male)
MUSB-CBL-7+	6.6 ft (2.0 m) USB Cable: USB type A(Male) to USB type Mini-B(Male)
CBL-RJ45-MM-5+	5 ft (1.5 m) Ethernet cable: RJ45(Male) to RJ45(Male) Cat 5E cable
BKT-66-02+	Bracket Kit

⁹ The USB-AC/DC-5 may be used to provide the 5V_{DC} power input via USB port if operating the RCDAT with Ethernet control. Not required if using USB control.

¹⁰ Power plugs for other countries are also available, Plugs for other countries are also available, if you need a power plug for a country not listed please contact testsolutions@minicircuits.com

Additional Notes

- A. Performance and quality attributes and conditions not expressly stated in this specification document are intended to be excluded and do not form a part of this specification document.
- B. Electrical specifications and performance data contained in this specification document are based on Mini-Circuit's applicable established test performance criteria and measurement instructions.
- C. The parts covered by this specification document are subject to Mini-Circuits standard limited warranty and terms and conditions (collectively, "Standard Terms"); Purchasers of this part are entitled to the rights and benefits contained therein. For a full statement of the Standard Terms and the exclusive rights and remedies thereunder, please visit Mini-Circuits' website at www.minicircuits.com/MCLStore/terms.jsp

