



USB & ETHERNET CONTROLLED

RF SPDT Switch Matrix **RC-1SPDT-A26**

50Ω DC to 26.5 GHz SMA-Female

THE BIG DEAL

- Mechanical SPDT switch
- Excellent performance to 26.5 GHz
- 30W power rating (cold switching)

APPLICATIONS

- 5G node / device testing
- Automated test equipment
- Fail-safe / redundancy switching



CASE STYLE: LM1848

[DOWNLOAD](#) SOFTWARE PACKAGE

RoHS Compliant
See our website for RoHS Compliance methodologies and qualifications

PRODUCT OVERVIEW

Mini-Circuits' RC-1SPDT-A26 is an independently controlled, electro-mechanical SPDT switch. The switch operates over an extremely wide bandwidth, from DC to 26.5 GHz with high isolation and low insertion loss. The absorptive switches are of a failsafe and break-before-make-configuration, with a lifetime of 2 million switching cycles when used within the noted specifications.

The switch box is constructed in a compact, rugged metal case (4.5 x 6.0 x 2.25") with all SMA (f) RF connectors on the front panel. The switches are controlled via USB or Ethernet, allowing control directly from a PC, or remotely over a network. Full software support is provided, including our user-friendly GUI application for Windows and a full API with programming instructions for Windows and Linux environments (both 32-bit and 64-bit systems).

KEY FEATURES

Feature	Advantages
Mechanical SPDT switch	Mechanical absorptive switches provide high reliability, repeatable high performance and internal terminations of input signals on the disconnected paths
Operation from DC to 26.5 GHz	Supports a wide range of RF test and signal routing applications, including 2G, 3G, 4G and 5G, with a single device
Break-before-make configuration	Prevents a momentary connection of the old and new signal paths, reducing the inconsistent transient effects that could otherwise be observed during switching
USB & Ethernet control	USB HID and Ethernet (HTTP / Telnet) interfaces provide easy compatibility with a wide range of software setups and programming environments
Full software support	User friendly Windows GUI (graphical user interface) allows manual control straight out of the box, while the comprehensive API (application programming interface) with examples and instructions allows easy automation in most programming environments

REV. C
ECO-013590
RC-1SPDT-A26
MCL NY
240124





USB & ETHERNET CONTROLLED

RF SPDT Switch Matrix RC-1SPDT-A26

Mini-Circuits

50Ω DC to 26.5 GHz SMA-Female

ELECTRICAL SPECIFICATIONS AT 25°C

Parameter	Conditions (GHz)	Min.	Typ.	Max.	Units
Frequency Range		DC		26.5	GHz
Insertion Loss	DC - 8	—	0.15	0.3	dB
	8 - 18	—	0.3	0.5	
	18 - 26.5	—	0.6	0.8	
Isolation	DC - 8	75	90	—	dB
	8 - 18	60	66	—	
	18 - 26.5	55	65	—	
VSWR	DC - 8	—	1.2	—	:1
	8 - 18	—	1.2	—	
	18 - 26.5	—	1.25	—	
Switching Time	—	—	25	—	ms
RF Input Power (Cold Switching) ¹	DC - 26.5	—	—	30	W
Switch Lifetime		—	2	—	million cycles
Rated Voltage	24V _{DC} input	23	24	25	V
	USB port	—	5	—	
Rated Current (24V DC Input)	All switches in state 2	—	295	—	mA
	All switches in state 1	—	75	120	
Rated Current (USB)		—	10	20	mA

1. Maximum power for any connected through path as stated; maximum power into any internal termination is 1W per port.

ABSOLUTE MAXIMUM RATINGS²

Parameters	Ratings
Operating Temperature	0°C to 40°C
Storage Temperature	-15°C to 85°C
Supply Voltage	26V

2. Permanent damage may occur if any of these limits are exceeded.





USB & ETHERNET CONTROLLED

RF SPDT Switch Matrix RC-1SPDT-A26

50Ω DC to 26.5 GHz SMA-Female

SWITCHING CONFIGURATION:

- Fail-safe absorptive (internal terminations on ports J1-J2)

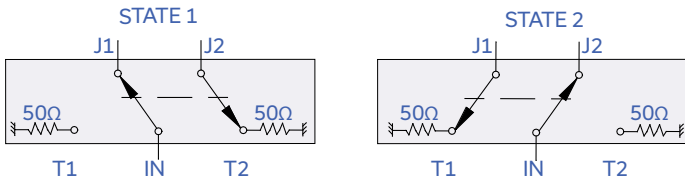

CONNECTIONS

Port Name	Connector Type
RF Switch A (Com, 1 & 2)	SMA female
USB	USB type-B
Ethernet / LAN	RJ45
24V DC Input	2.1mm center positive DC socket

OUTLINE DRAWING (LM1848)

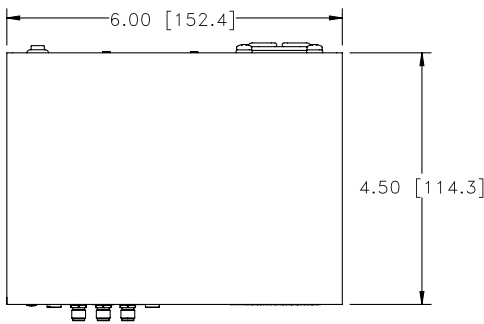

TOP VIEW

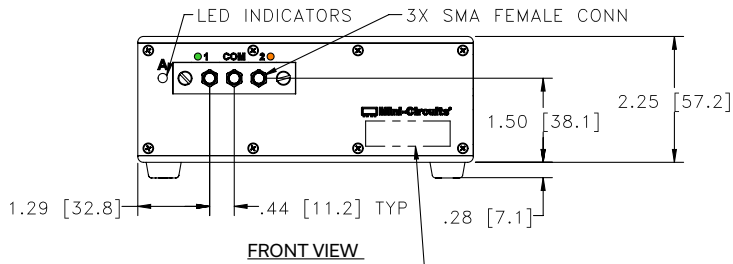

FRONT VIEW

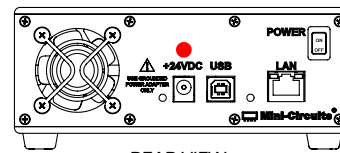

REAR VIEW

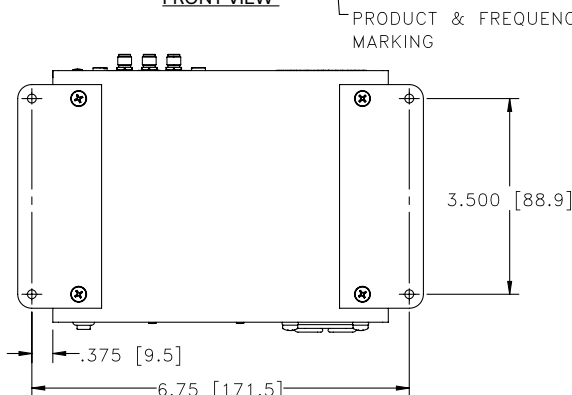

BOTTOM VIEW

SHOWN WITH RUBBER FEET REMOVED AND BRACKETS INSTALLED.

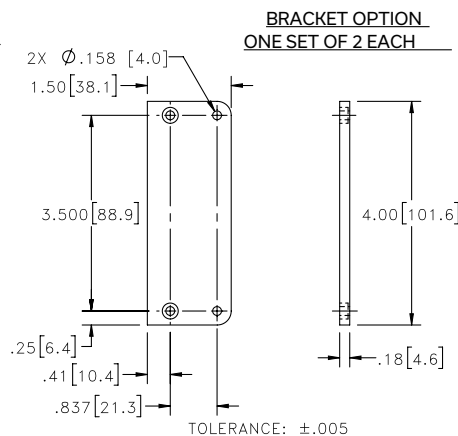

TOLERANCE: ±.005

INSTRUCTIONS FOR MOUNTING BRACKETS:

TOOL REQUIRED: PHILLIPS HEAD SCREWDRIVER

STEP 1: REMOVE RUBBER FEET FROM THE BOTTOM OF THE UNIT. DO NOT DISCARD THE FASTENERS.

STEP 2: MOUNT THE BRACKETS WITH THE FASTENERS

REMOVED IN STEP 1, USING THE COUNTER BORE HOLES IN THE BRACKET.

Weight: 857 grams.

Dimensions are in inches [mm]. Tolerances: 2 Pl. ±.03 inch; 3 Pl. ±.015 inch.





USB & ETHERNET CONTROLLED

RF SPDT Switch Matrix RC-1SPDT-A26

Mini-Circuits

50Ω DC to 26.5 GHz SMA-Female

TYPICAL PERFORMANCE DATA / CURVES

FREQ. (MHz)	ON INSERTION LOSS (dB)		OFF ISOLATION (dB)		VSWR, IN (:1)		VSWR (J2) (:1)		VSWR (J1) (:1)	
	IN-J2	IN-J2	IN-J1	IN-J2	State 1	State 2	State 1	State 2	State 1	State 2
100	0.01	0.01	104.63	104.43	1.00	1.01	1.01	1.01	1.00	1.00
1000	0.03	0.03	104.09	110.67	1.03	1.02	1.03	1.02	1.02	1.03
2000	0.04	0.04	111.02	95.70	1.06	1.04	1.06	1.05	1.04	1.05
4000	0.05	0.05	97.46	113.60	1.03	1.03	1.03	1.06	1.02	1.06
6000	0.06	0.06	105.14	100.69	1.07	1.08	1.07	1.06	1.08	1.04
8000	0.08	0.08	100.30	104.86	1.08	1.11	1.08	1.06	1.10	1.02
10000	0.08	0.08	99.85	89.69	1.05	1.06	1.03	1.04	1.07	1.02
12000	0.10	0.09	102.84	84.40	1.09	1.07	1.09	1.05	1.07	1.01
14000	0.10	0.11	94.10	81.60	1.03	1.06	1.01	1.11	1.05	1.07
16000	0.11	0.12	88.22	82.14	1.02	1.01	1.03	1.10	1.03	1.07
18000	0.14	0.16	92.71	81.05	1.14	1.17	1.15	1.02	1.17	1.05
20000	0.15	0.19	108.55	79.09	1.18	1.21	1.18	1.13	1.21	1.16
22000	0.13	0.16	84.47	76.16	1.03	1.04	1.02	1.12	1.03	1.18
24000	0.16	0.22	90.92	76.74	1.16	1.17	1.14	1.34	1.19	1.34
26500	0.35	0.59	97.36	73.07	1.52	1.62	1.51	1.61	1.68	1.44

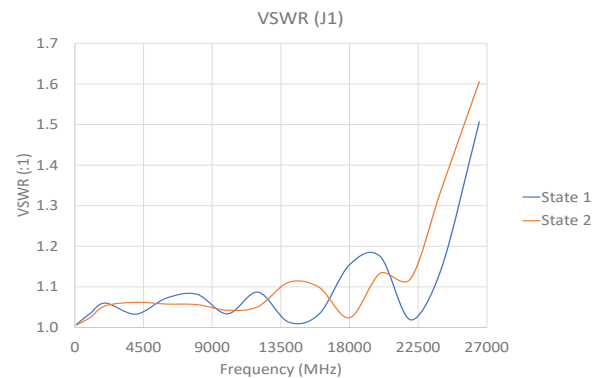
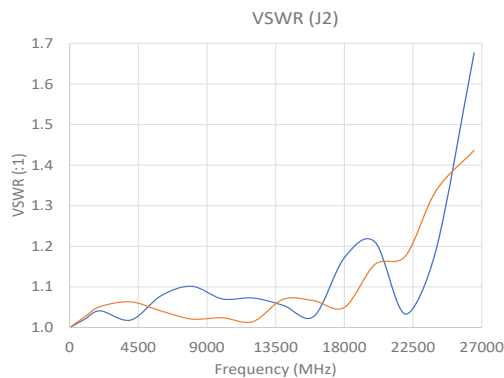
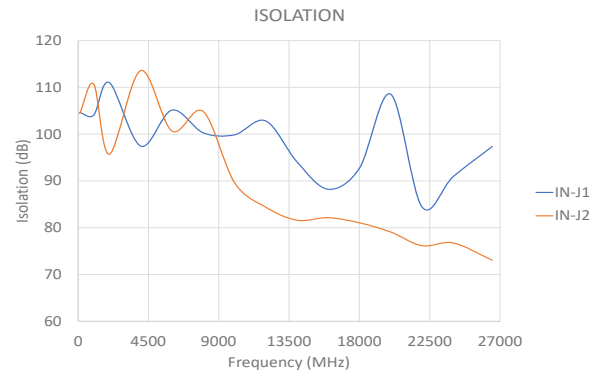



USB & ETHERNET CONTROLLED

RF SPDT Switch Matrix **RC-1SPDT-A26**

Mini-Circuits

50Ω DC to 26.5 GHz SMA-Female

SOFTWARE SPECIFICATIONS

SOFTWARE & DOCUMENTATION DOWNLOAD:

- Mini-Circuits' full software and support package including user guide, Windows GUI, DLL files, programming manual and examples can be downloaded free of charge from: <https://www.minicircuits.com/softwaredownload/rfswitchcontroller.html>
- Please contact testsolutions@minicircuits.com for support

MINIMUM SYSTEM REQUIREMENTS:

Parameter	Requirements	
Interface	USB HID & Ethernet (HTTP & Telnet)	
System Requirements	GUI	Windows 98 or later
	USB API DLL	Windows 98 or later and programming environment with ActiveX or .NET support
	USB Direct Programming	Linux, Windows 98 or later
	Ethernet	Windows, Linux or Mac computer with a network port and Ethernet TCP/IP support
Hardware	Pentium II or later with 256 MB RAM	

APPLICATION PROGRAMMING INTERFACE (API)

ETHERNET SUPPORT:

- Simple ASCII / SCPI command set for attenuator control
- Communication via HTTP or Telnet
- Supported by most common programming environments

USB SUPPORT (WINDOWS):

- ActiveX COM DLL file for creation of 32-bit programs
- .NET library DLL file for creation of 32 / 64-bit programs
- Supported by most common programming environments (refer to application note AN-49-001 for summary of supported environments)

USB SUPPORT (LINUX):

- Direct USB programming using a series of USB interrupt codes

Full programming instructions and examples available for a wide range of programming environments / languages.



USB & ETHERNET CONTROLLED

RF SPDT Switch Matrix RC-1SPDT-A26

50Ω DC to 26.5 GHz SMA-Female

GRAPHICAL USER INTERFACE (GUI) FOR WINDOWS - KEY FEATURES

- Connect via USB or Ethernet
- Run GUI in "demo mode" to evaluate software without a hardware connection

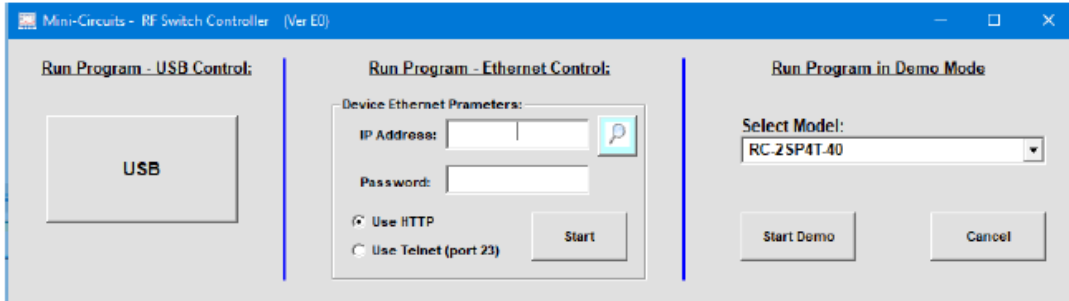

- View and set switch states at the click of a button
- Configure and run timed switching sequences
- Set start-up switch state
- Configure Ethernet IP settings

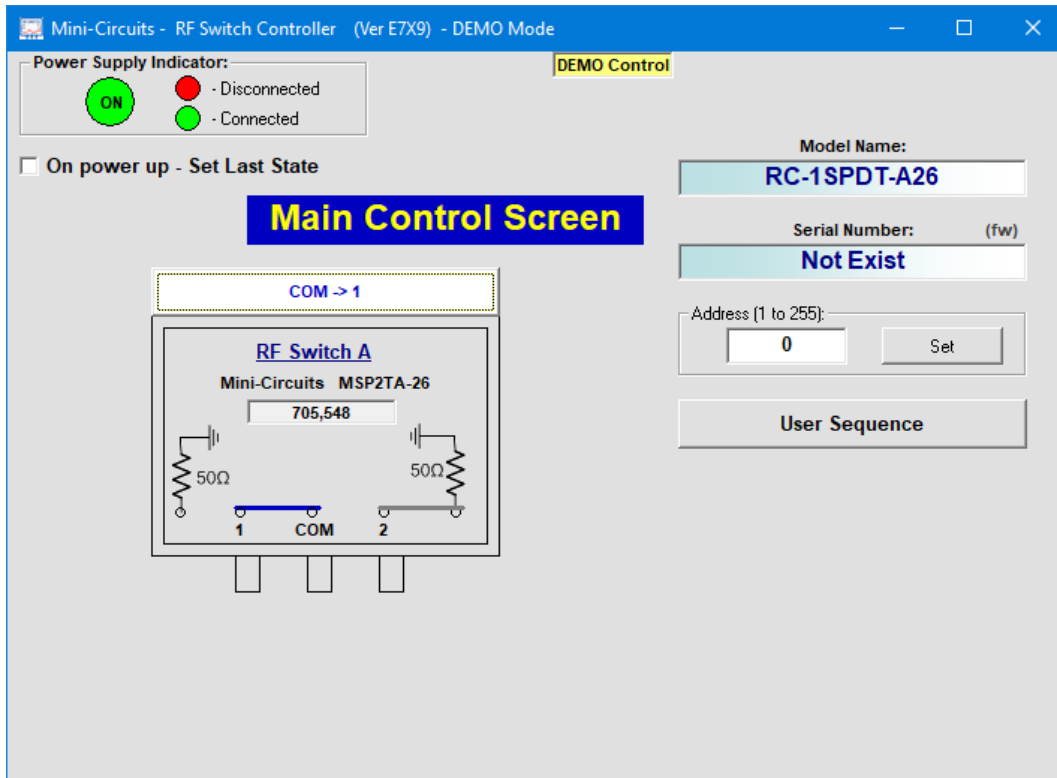



USB & ETHERNET CONTROLLED

RF SPDT Switch Matrix RC-1SPDT-A26

Mini-Circuits



50Ω DC to 26.5 GHz SMA-Female





ORDERING INFORMATION

Refer to Mini-Circuits' website for pricing and availability information:

<https://www.minicircuits.com/WebStore/dashboard.html?model=RC-1SPDT-A26>

Model	Description
RC-1SPDT-A26	USB & Ethernet controlled SPDT switch matrix

Included Accessories	Part No.	Description
	AC/DC-24-3W1	AC/DC 24V _{DC} Grounded Power Adaptor. Operating temperature: 0°C to +40°C, I _{Max} =2.5A
See Below	CBL-3W1-XX	AC Power Cord (Select one power cord from below with each Switch Matrix box)
	USB-CBL-AB-3+	2.7 ft (0.8 m) USB Cable: USB type A(Male) to USB type B(Male)

AC Power Cords ³	Part No.	Description
	CBL-3W1-US	Power Cord for United States
	CBL-3W1-EU	Power Cord for Europe
	CBL-3W1-UK	Power Cord for United Kingdom
	CBL-3W1-AU	Power Cord for Australia and China
	CBL-3W1-IL	Power Cord for Israel

3. If you need a Power cord for a country not listed please contact testsolutions@minicircuits.com

OPTIONAL ACCESSORIES

USB-CBL-AB-3+	2.7 ft (0.8 m) USB Cable: USB type A(Male) to USB type B(Male)
USB-CBL-AB-7+	6.8 ft (2.1 m) USB Cable: USB type A(Male) to USB type B(Male)
USB-CBL-AB-11+	11 ft (3.4 m) USB Cable: USB type A(Male) to USB type B(Male)
CBL-RJ45-MM-5+	5 ft (1.5 m) Ethernet cable: RJ45(Male) to RJ45(Male) Cat 5E cable
BKT-272-08+	Bracket (One set of 2 each)

- NOTES**
- A. Performance and quality attributes and conditions not expressly stated in this specification document are intended to be excluded and do not form a part of this specification document.
 - B. Electrical specifications and performance data contained in this specification document are based on Mini-Circuit's applicable established test performance criteria and measurement instructions.
 - C. The parts covered by this specification document are subject to Mini-Circuits standard limited warranty and terms and conditions (collectively, "Standard Terms"); Purchasers of this part are entitled to the rights and benefits contained therein. For a full statement of the standard. Terms and the exclusive rights and remedies thereunder, please visit Mini-Circuits' website at www.minicircuits.com/MCLStore/terms.jsp

