



STRIPLINE SURFACE MOUNT

Power Splitter/Combiner

QCH-63+

Mini-Circuits

50Ω 2000 to 6000 MHz 2-Way 90° 200W

KEY FEATURES

- High power handling, up to 200W
- Ultra wide bandwidth
- Excellent phase unbalance, ± 1.5 deg

APPLICATIONS

- Balanced amplifiers
- I&Q modulators
- Defense and military



Generic photo used for illustration purposes only

FUNCTIONAL DIAGRAM

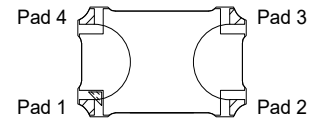

PRODUCT OVERVIEW

Mini-Circuits' QCH-63+ is a 2-way 90° power splitter, capable of handling up to 200W with amplitude unbalance of ± 1.4 dB typ and phase unbalance of ± 1.5 deg. typ. Operating over a frequency range of 2000 to 6000 MHz, the outstanding phase and amplitude unbalance make this component a versatile building block for use in a variety of systems and sub-system designs from balanced amplifiers and antenna feeds to military applications and more. The splitter is fabricated using laminated PCB process (0.56 x 0.35 x 0.093") and includes wrap-around terminations for good solderability and easy visual inspection.

ELECTRICAL SPECIFICATIONS ^{1,2} AT +25°C

Parameter	Conditions (MHz)	Min.	Typ.	Max.	Unit
Frequency Range	-	2000	-	6000	MHz
Mainline Loss ³	2000 - 6000	-	0.20	0.40	dB
Isolation	2000 - 6000	18	26	-	dB
Phase Unbalance	2000 - 6000	-	± 1.50	± 7.50	deg
Amplitude Unbalance	2000 - 6000	-	± 1.40	± 1.50	dB
Return Loss	2000 - 6000	17.5	23	-	dB
Thermal Resistance ⁴	2000 - 6000	-	0.35	-	°C/W

1. Tested in Evaluation Board TB-906+. De-embedded to the device reference plane.

2. Model is symmetrical and all ports are interchangeable, see Port Function Description/Configuration table for details and S-Parameters for actual performance.

3. Does not include theoretical loss due to coupling. Nominal theoretical loss is 3 dB.

4. Thermal Resistance is defined as $\theta_{jc} = (\text{Hot Spot Temperature on DUT} - \text{Base Plate Temperature}) / \text{Input Power}$.

ABSOLUTE MAXIMUM RATINGS ⁵

Operating Case Temperature ⁶	-55°C to +105°C	
Storage Temperature	-55°C to +105°C	
Power Input	+85°C case	200 W
	+95°C case	150 W
	+105°C case	120 W

5. Permanent damage may occur if any of these limits are exceeded.

6. Case temperature is defined as temperature on base plate.





STRIPLINE SURFACE MOUNT

Power Splitter/Combiner

QCH-63+

Mini-Circuits

50Ω 2000 to 6000 MHz 2-Way 90° 200W

TYPICAL PERFORMANCE GRAPHS*

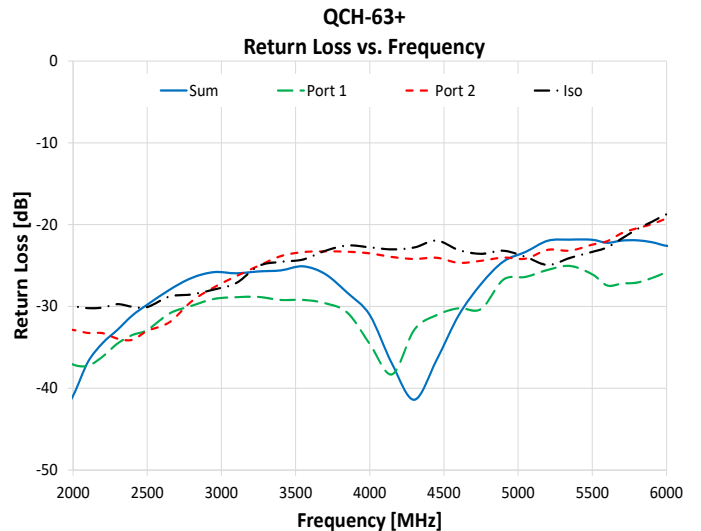
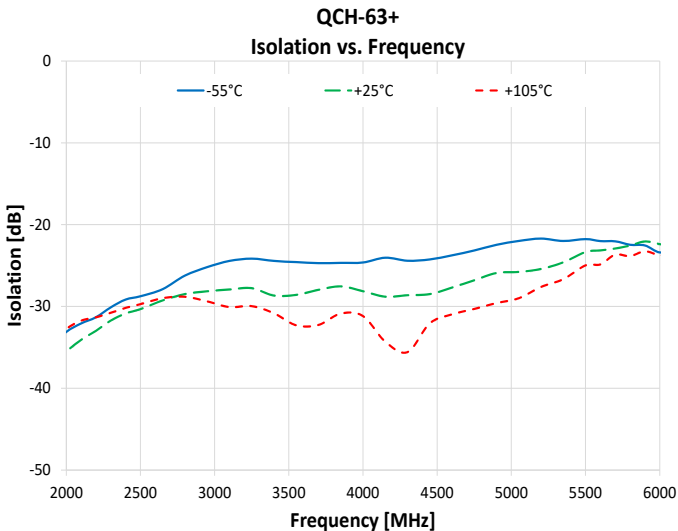
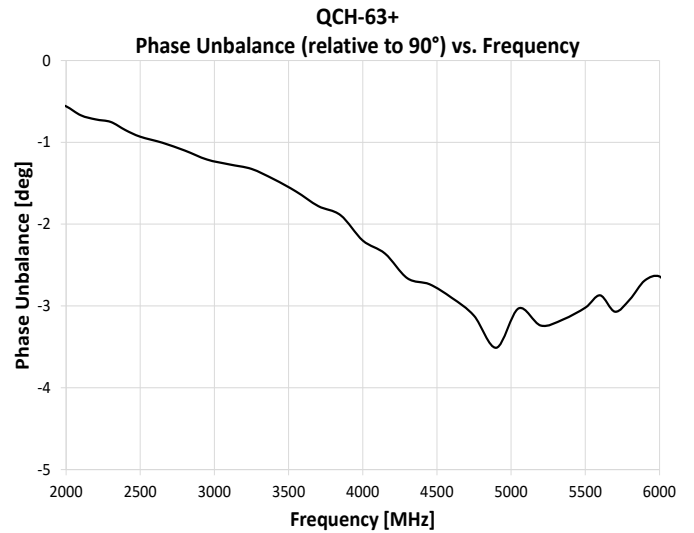
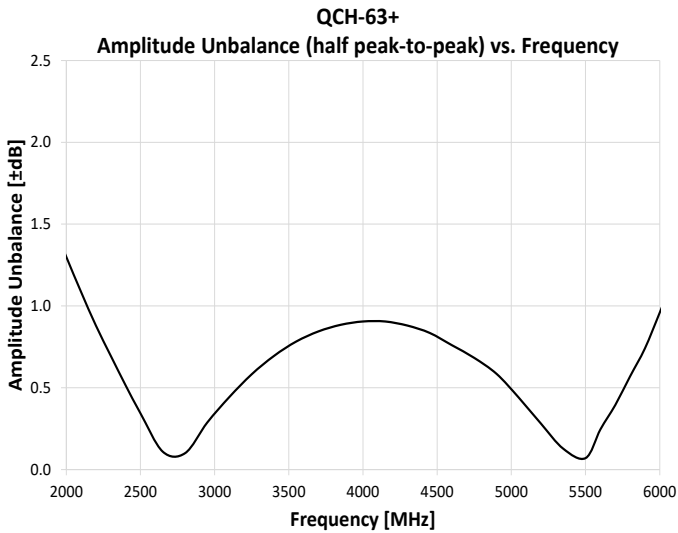
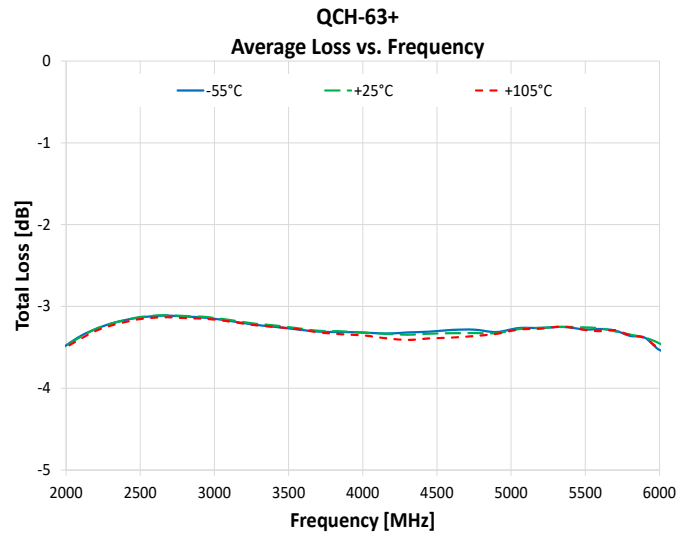
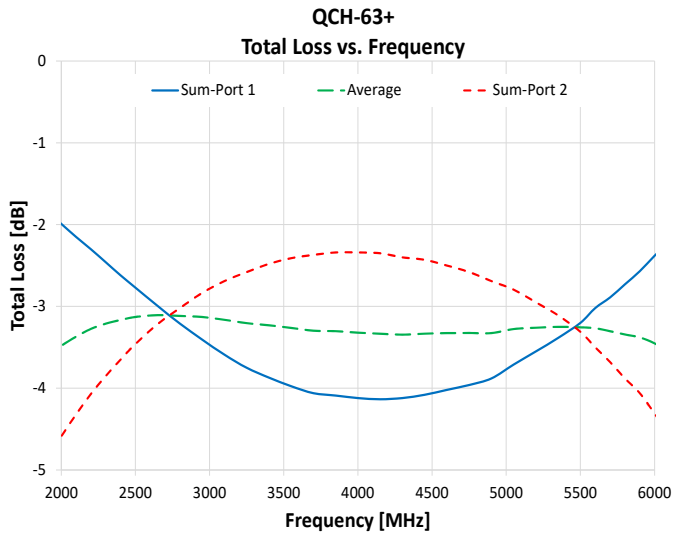

* Data corresponds to Configuration A at +25°C unless otherwise specified.





STRIPLINE SURFACE MOUNT

Power Splitter/Combiner

QCH-63+

Mini-Circuits

50Ω 2000 to 6000 MHz 2-Way 90° 200W

FUNCTIONAL DIAGRAM

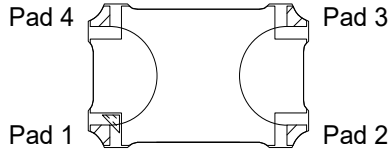

PAD DESCRIPTION/CONFIGURATION 7

Function	Pad	Description
Sum	1	Sum port
Isolation	2	Isolation port
Port 2 (90°)	3	90° port
Port 1 (0°)	4	0° port
Ground	5	Ground

Configuration	Sum	Isolation	Port 1 (0°)	Port 2 (90°)
A	1	2	4	3
B	2	1	3	4
C	3	4	2	1
D	4	3	1	2

7. Model is symmetrical and all ports are interchangeable, see Port Function Configurations table and s-parameters for actual performance.

SUGGESTED PCB LAYOUT (PL-528)

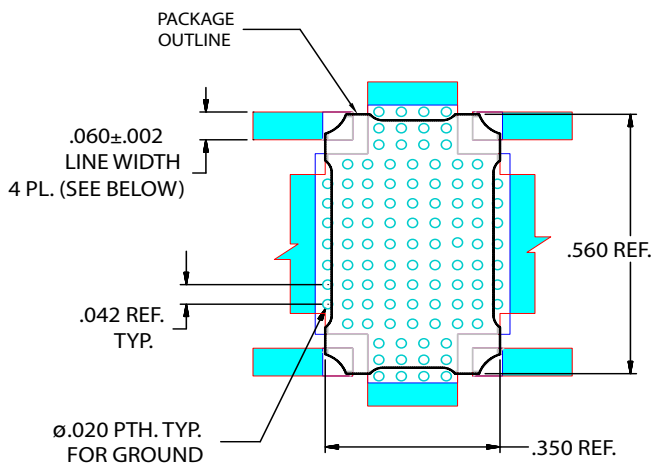

- NOTES:
- TRACE WIDTH IS SHOWN FOR ROGERS RT/DUROID5880 WITH DIELECTRIC THICKNESS 0.02±.0015". COPPER: 1 OZ. EACH SIDE. FOR OTHER MATERIALS TRACE WIDTH MAY NEED TO BE MODIFIED.
 - BOTTOM SIDE OF THE PCB IS CONTINUOUS GROUND PLANE.
- DENOTES PCB COPPER LAYOUT WITH SMOBC (SOLDER MASK OVER BARE COPPER)
 - DENOTES COPPER LAND PATTERN FREE OF SOLDERMASK

CASE STYLE DRAWING (PQ2186)

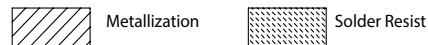
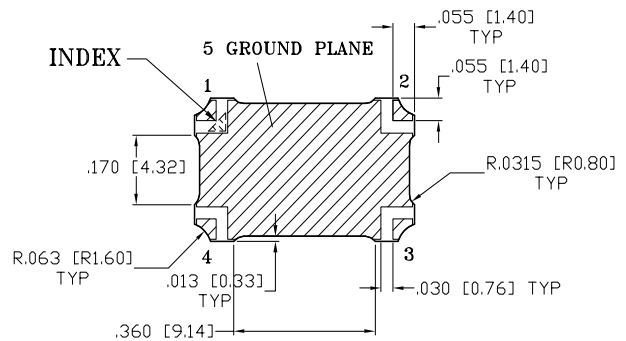
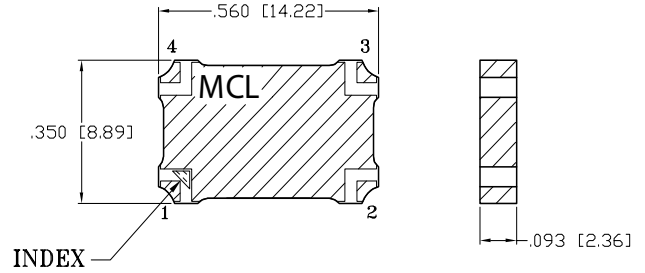

NOTES:

- Base material: Printed wiring laminate.
- Termination finish: 2-5 μinch (.05-.13 microns) Immersion Gold.
- Weight: 1.4 grams
- Marking may contain other features or characters for internal lot control.

PRODUCT MARKING*: QCH-63+

* Marking may contain other features or characters for internal lot control.



STRIPLINE SURFACE MOUNT

Power Splitter/Combiner

QCH-63+



50Ω 2000 to 6000 MHz 2-Way 90° 200W

ADDITIONAL DETAILED INFORMATION IS AVAILABLE ON OUR DASH BOARD

[CLICK HERE](#)

Performance Data & Graphs	Data Graphs S-Parameter (S4P files) data set (.zip file) de-embedded to device pads
Case Style	PQ2186 Lead finish: 2-5 inch (0.05-0.13 microns) immersion gold
RoHS Status	Compliant
Tape and Reel	F118
Suggested Layout for PCB Design	PL-528
Evaluation Board	TB-906+ Gerber file
Environmental Rating	ENV02T8

NOTES:

- A. Performance and quality attributes and conditions not expressly stated in this specification document are intended to be excluded and do not form a part of this specification document.
- B. Electrical specifications and performance data contained in this specification document are based on Mini-Circuit's applicable established test performance criteria and measurement instructions.
- C. The parts covered by this specification document are subject to Mini-Circuits standard limited warranty and terms and conditions (collectively, "Standard Terms"); Purchasers of this part are entitled to the rights and benefits contained therein. For a full statement of the Standard Terms and the exclusive rights and remedies thereunder, please visit Mini-Circuits' website at <https://www.minicircuits.com/terms/viewterm.html>

