



MMIC SURFACE MOUNT

Power Amplifier

PMA5-83-2W+

50 Ω 0.01 to 10 GHz 2 W P_{SAT}

THE BIG DEAL

- P1dB, Typ. +31 dBm
- P_{SAT}, Typ. +33 dBm
- Low Noise Figure, Typ. 3.5 dB
- High OIP3, Typ. +43.5 dBm
- Supply Voltage +12 V, 400 mA
- 5x5 mm 32-Lead QFN-Style Package

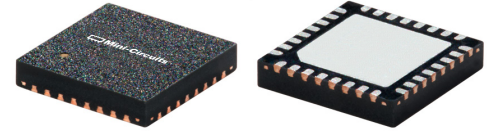

Generic photo used for illustration purposes only

APPLICATIONS

- Test and Measurement Equipment
- Radar, EW, and ECM Defense Systems
- 5G Sub6, MIMO Wireless Infrastructure Systems
- Microwave Radio & VSAT

FUNCTIONAL DIAGRAM

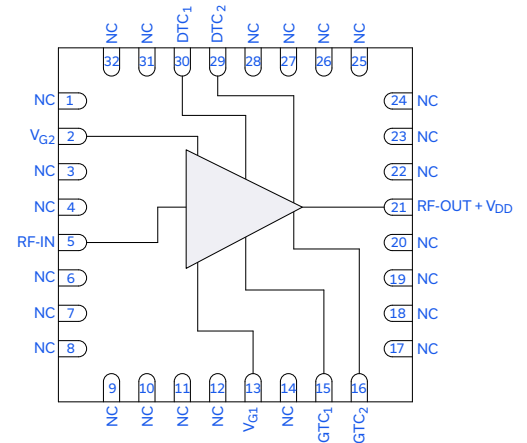

PRODUCT OVERVIEW

The PMA5-83-2W+ is a GaAs MMIC Distributed Power Amplifier operating from 0.01 to 10 GHz. The amplifier provides 12 dB of gain, +33 dBm saturated output power, and achieves +43.5 dBm output IP3, while operating from a +12 V power supply and consuming 400 mA of current. In addition, it is internally matched to 50 Ohms and comes in a 5x5 mm 32-Lead QFN-Style package. These characteristics make it ideally suited for wideband test instrumentation and defense systems that require high operating output power, while maintaining very low distortion characteristics.

KEY FEATURES

Feature	Advantages
High P1dB Typ. +31 dBm	Flat gain and output power make this device excellent for wideband systems from 0.01 to 10 GHz that require at least 1W of operating output power over the full band.
Low Noise Figure Typ. 3.5 dB	High operating output power accompanied with low noise figure enables a significant signal to noise ratio advantage for systems requiring high dynamic range.
High OIP3 Typ. +43.5 dBm	High operating OIP3 and low 2nd and 3rd harmonic response provides for very low in-band distortion products, which is typically needed for high fidelity measurement systems.
5x5 mm 32-Lead QFN-Style Package	Small footprint saves space in dense layouts while providing low inductance, repeatable transitions, and excellent thermal contact to the PCB. Industry standard packaging allows for ease of assembly in high volume manufacturing processes.





MMIC SURFACE MOUNT

Power Amplifier

PMA5-83-2W+

Mini-Circuits

50 Ω 0.01 to 10 GHz 2 W P_{SAT}

ELECTRICAL SPECIFICATIONS¹ AT 25°C, V_{DD}= +12 V, UNLESS NOTED OTHERWISE

Parameter	Condition (GHz)	Min.	Typ.	Max.	Units
Frequency Range		0.01		10	GHz
Gain	0.01		17.9		dB
	2		12.3		
	4		12.0		
	6		11.9		
	8		11.3		
	10		10.3		
Output Power at 1 dB Compression (P _{1dB})	0.01		+30.6		dBm
	2		+31.0		
	4		+31.3		
	6		+31.5		
	8		+31.1		
	10		+31.0		
Output Power at Saturation (P _{SAT}) ²	0.01		+35.6		dBm
	2		+32.9		
	4		+33.0		
	6		+33.5		
	8		+33.3		
	10		+32.2		
Output Third-Order Intercept (P _{OUT} = +20 dBm/Tone)	0.01		+36.8		dBm
	2		+44.1		
	4		+43.3		
	6		+42.2		
	8		+40.6		
	10		+38.5		
Output Second-Order Intercept (P _{OUT} = +20 dBm/Tone)	0.01		+63.1		dBm
	2		+44.5		
	4		+42.3		
	6		+42.1		
	8		+46.1		
	10		+53.4		
2nd Harmonics ³ (P _{OUT} = +10 dBm/Tone)	0.01		-61.0		dBc
	2		-42.5		
	4		-40.4		
	6		-39.9		
	8		-44.2		
	10		-50.6		
Input Return Loss	0.01		23		dB
	2		12		
	4		17		
	6		24		
	8		23		
	10		33		





MMIC SURFACE MOUNT

Power Amplifier

PMA5-83-2W+

50 Ω 0.01 to 10 GHz 2 W P_{SAT}

ELECTRICAL SPECIFICATIONS¹ AT 25°C, V_{DD}= +12 V, UNLESS NOTED OTHERWISE (CONTINUED)

Parameter	Condition (GHz)	Min.	Typ.	Max.	Units
Output Return Loss	0.01		24		dB
	2		12		
	4		10		
	6		14		
	8		12		
	10		12		
Isolation	0.01		50		dB
	2		47		
	4		42		
	6		38		
	8		36		
	10		34		
Noise Figure	0.5		6.8		dB
	2		3.7		
	4		2.8		
	6		2.9		
	8		3.3		
	10		4.1		
Device Operating Voltage (V _{DD})			+12	+16	V
Device Operating Current (I _{DD}) ⁴			400		mA
Gate Voltage (V _{G1})			-0.8		V
Gate Current (I _{G1})			15	4,000	μA
Gate Voltage (V _{G2})			+5		V
Gate Current (I _{G2})			15	4,000	μA
DC Current Variation vs. Temperature ⁵			11		μA/°C

1. Tested on Mini-Circuits Characterization Test Board. See Figure 2. Board loss de-embedded.
2. P_{SAT} defined as when the Output Power changes 0.1 dB per 1 dB change in Input Power.
3. 2nd harmonic measured at 2x the input frequency shown.
4. Current at P_{IN} = -25 dBm. Increases to ~650 mA at P1dB.
5. (Current at +85°C - Current at -45°C)/(130°C). V_{GS} held constant over temperature.



MMIC SURFACE MOUNT

Power Amplifier

PMA5-83-2W+

Mini-Circuits

50 Ω 0.01 to 10 GHz 2 W P_{SAT}

TYPICAL PERFORMANCE GRAPHS

GAIN vs. TEMPERATURE,
P_{IN} = -25 dBm, V_{DD} = +12 V

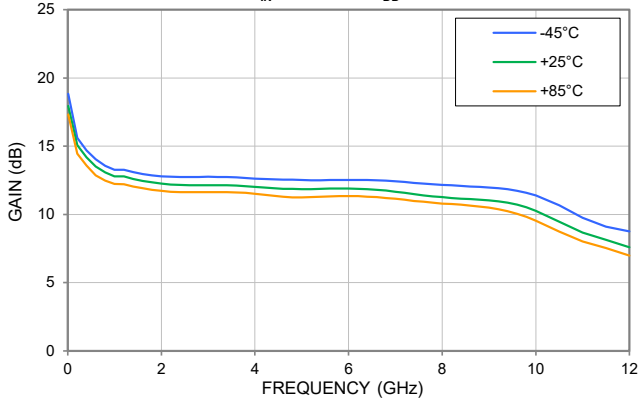

GAIN vs. DEVICE VOLTAGE,
P_{IN} = -25 dBm, TEMPERATURE = +25°C

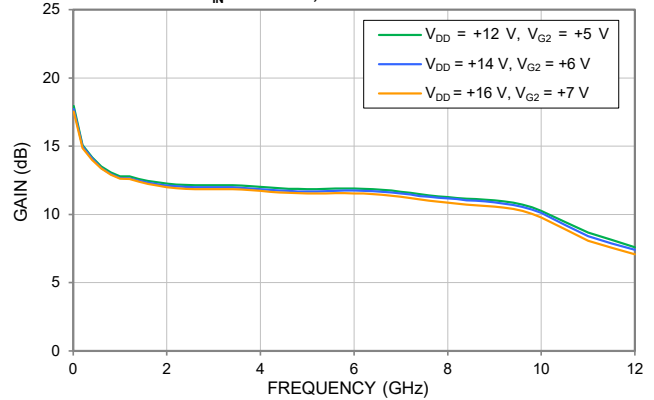

INPUT RETURN LOSS vs. TEMPERATURE,
P_{IN} = -25 dBm, V_{DD} = +12 V

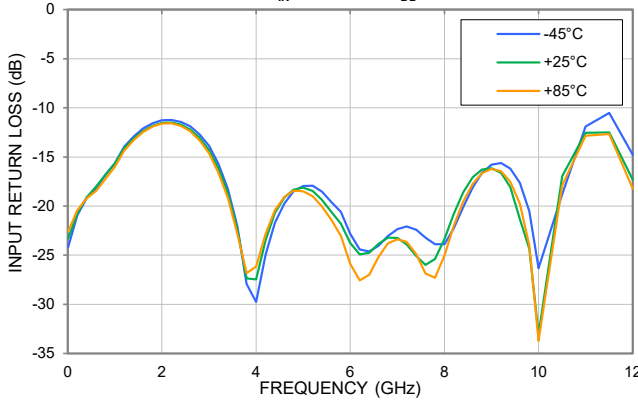

INPUT RETURN LOSS vs. DEVICE VOLTAGE,
P_{IN} = -25 dBm, TEMPERATURE = +25°C

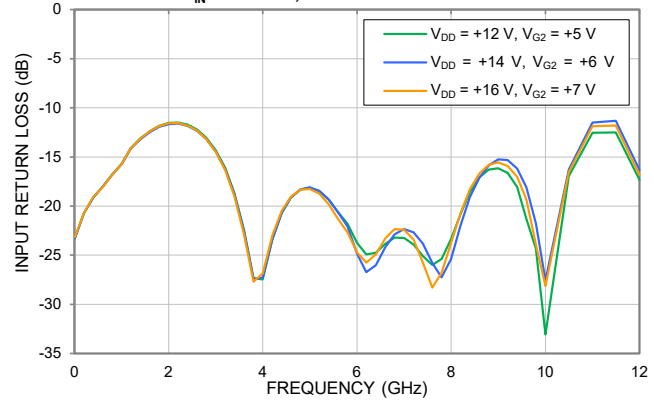

OUTPUT RETURN LOSS vs. TEMPERATURE,
P_{IN} = -25 dBm, V_{DD} = +12 V

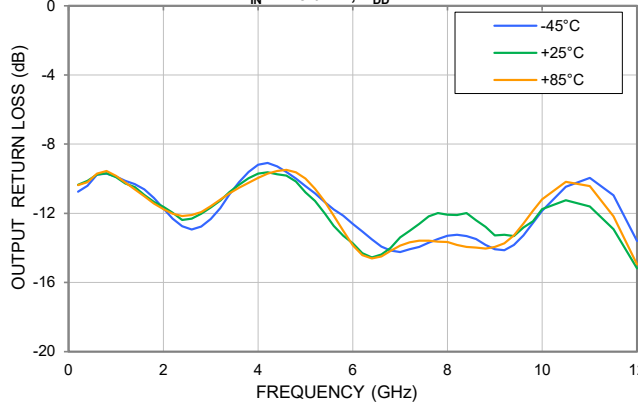

OUTPUT RETURN LOSS vs. DEVICE VOLTAGE,
P_{IN} = -25 dBm, TEMPERATURE = +25°C

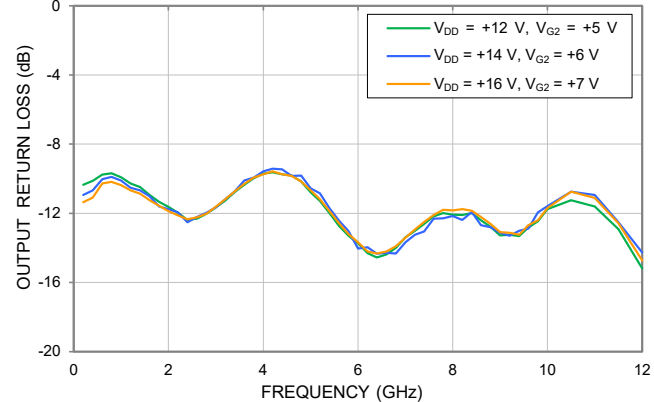



MMIC SURFACE MOUNT

Power Amplifier

PMA5-83-2W+

Mini-Circuits

50 Ω 0.01 to 10 GHz 2 W P_{SAT}

TYPICAL PERFORMANCE GRAPHS

ISOLATION vs. TEMPERATURE,
P_{IN} = -25 dBm, V_{DD} = +12 V

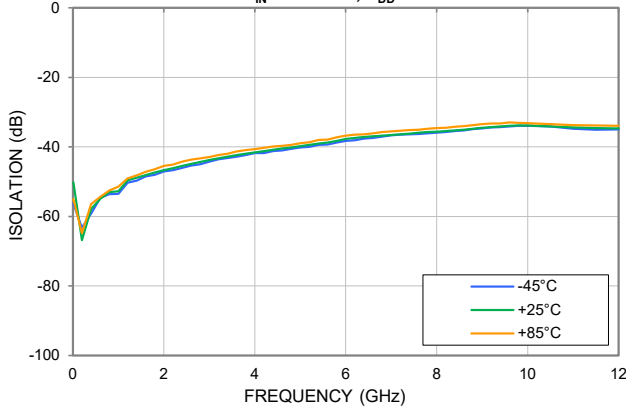

ISOLATION vs. DEVICE VOLTAGE,
P_{IN} = -25 dBm, TEMPERATURE = +25°C

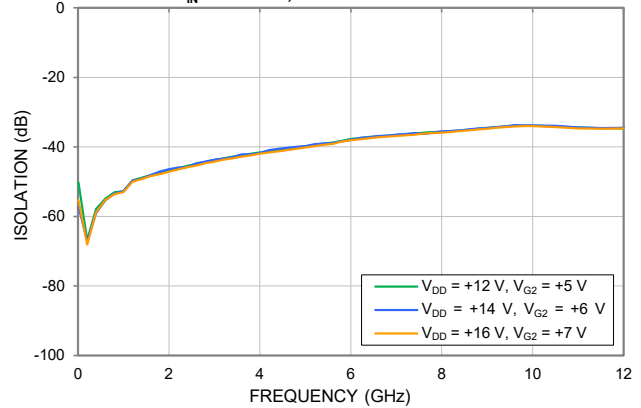

P_{1dB} vs. TEMPERATURE,
V_{DD} = +12 V

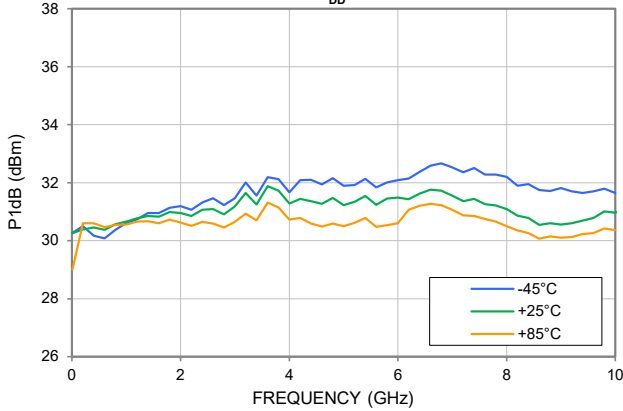

P_{1dB} vs. DEVICE VOLTAGE,
TEMPERATURE = +25°C

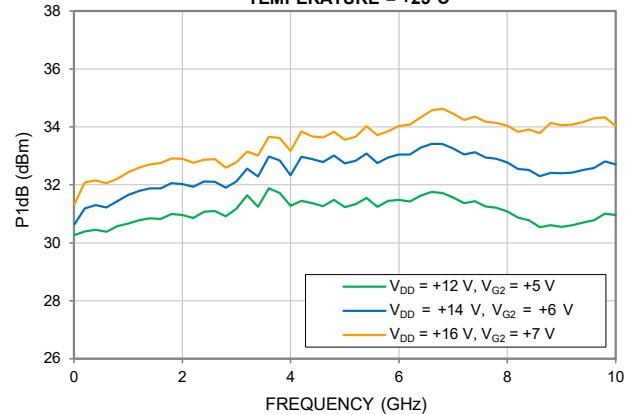

P_{SAT} vs. TEMPERATURE,
V_{DD} = +12 V

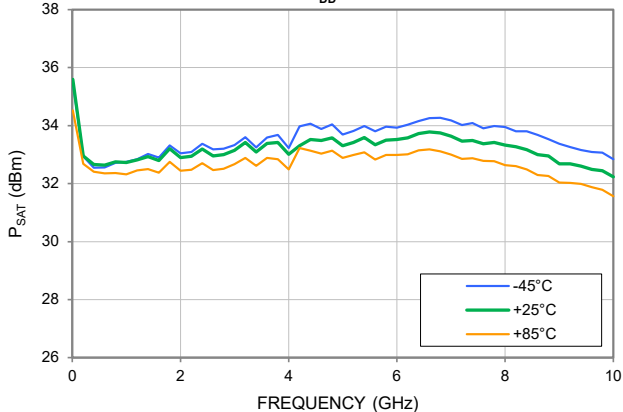

P_{SAT} vs. DEVICE VOLTAGE,
TEMPERATURE = +25°C

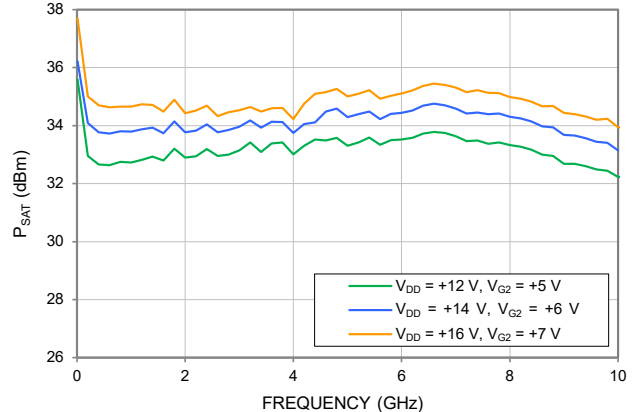



TYPICAL PERFORMANCE GRAPHS

OUTPUT IP3 vs. TEMPERATURE,
P_{OUT} = +20 dBm/TONE, V_{DD} = +12 V

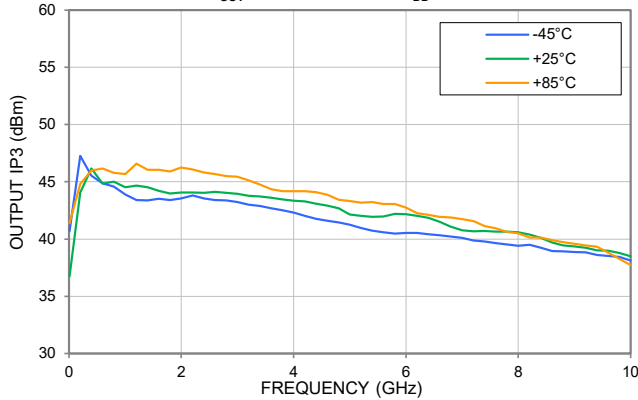

OUTPUT IP3 vs. DEVICE VOLTAGE,
P_{OUT} = +20 dBm/TONE, TEMPERATURE = +25°C

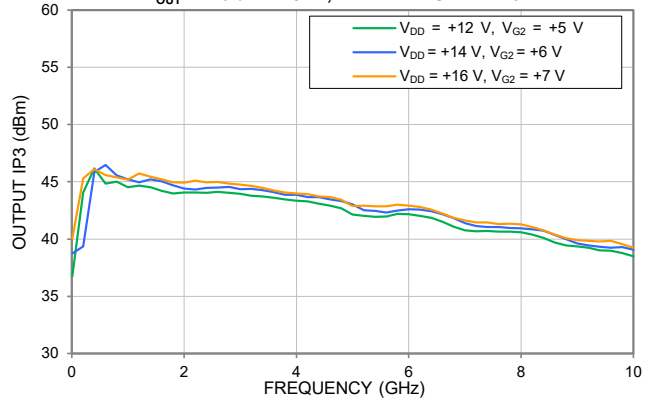

NOISE FIGURE vs. TEMPERATURE,
V_{DD} = +12 V

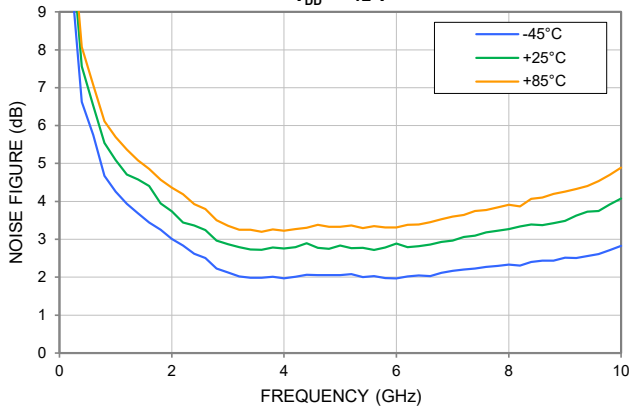

NOISE FIGURE vs. DEVICE VOLTAGE,
TEMPERATURE = +25°C

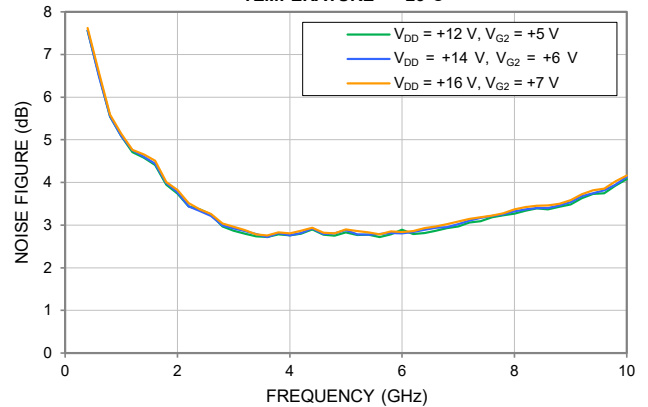

2ND HARMONICS vs. DEVICE VOLTAGE,
P_{OUT} = +10 dBm, TEMPERATURE = +25°C

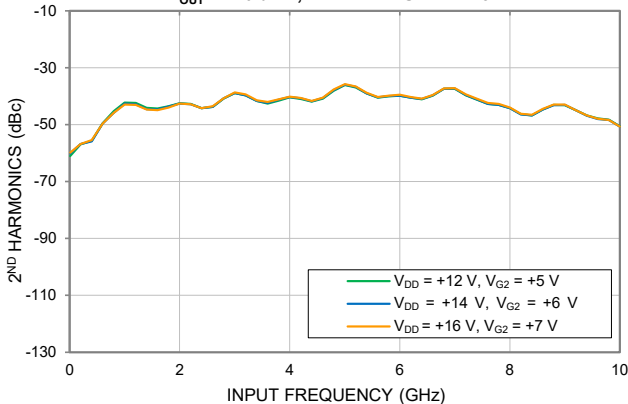

3RD HARMONICS vs. DEVICE VOLTAGE,
P_{OUT} = +10 dBm, TEMPERATURE = +25°C

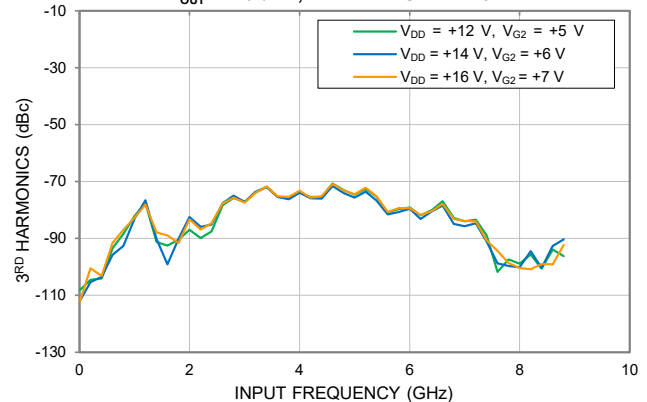



MMIC SURFACE MOUNT

Power Amplifier

PMA5-83-2W+

Mini-Circuits

50 Ω 0.01 to 10 GHz 2 W P_{SAT}

TYPICAL PERFORMANCE GRAPHS

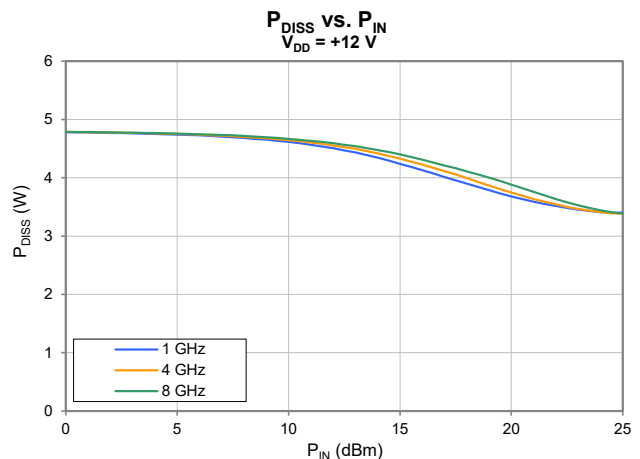
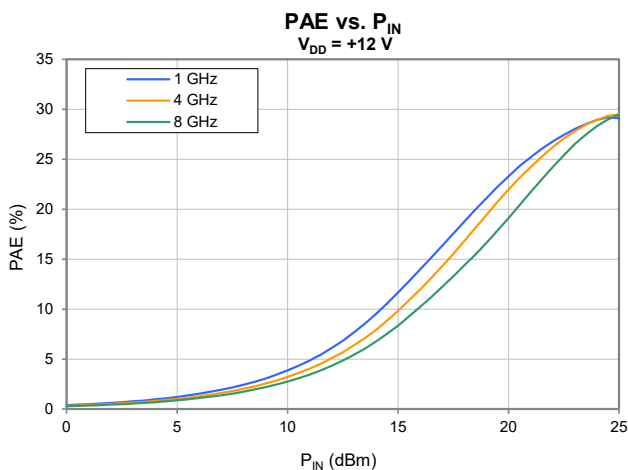
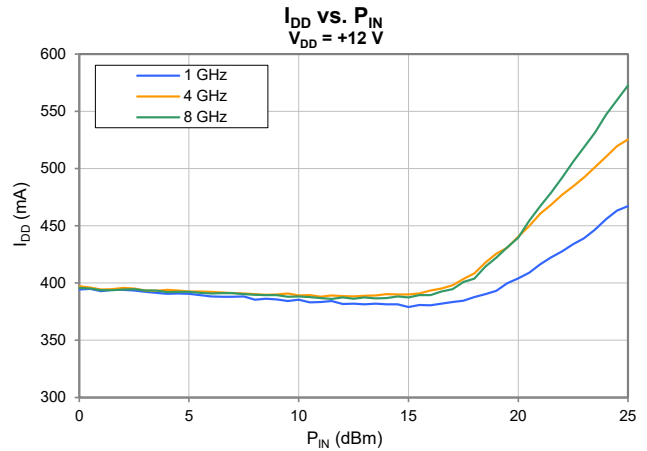
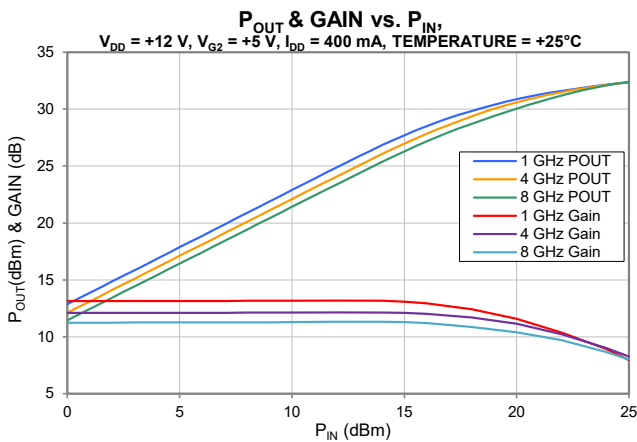
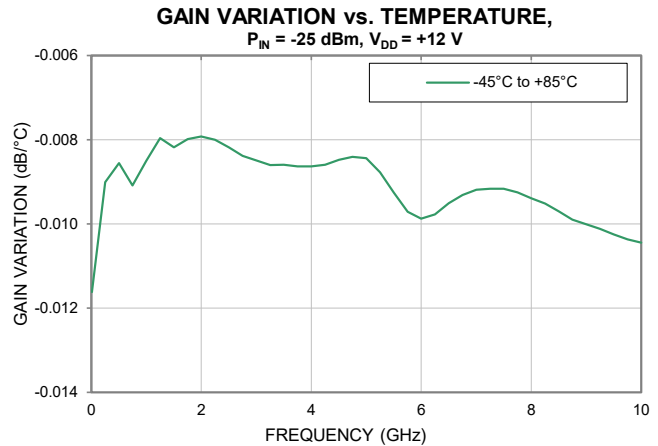
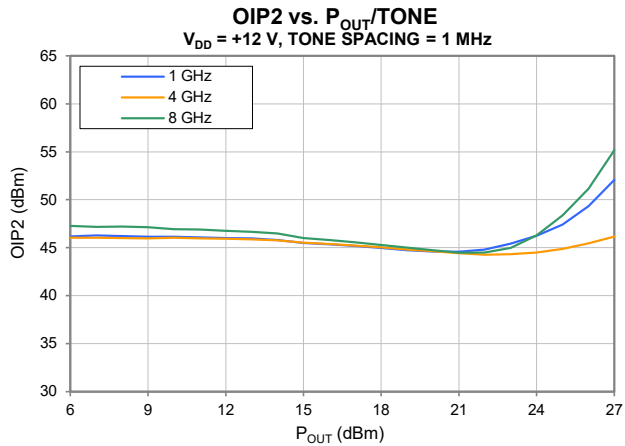



MMIC SURFACE MOUNT

Power Amplifier

PMA5-83-2W+

Mini-Circuits

50 Ω 0.01 to 10 GHz 2 W P_{SAT}

TYPICAL PERFORMANCE GRAPHS

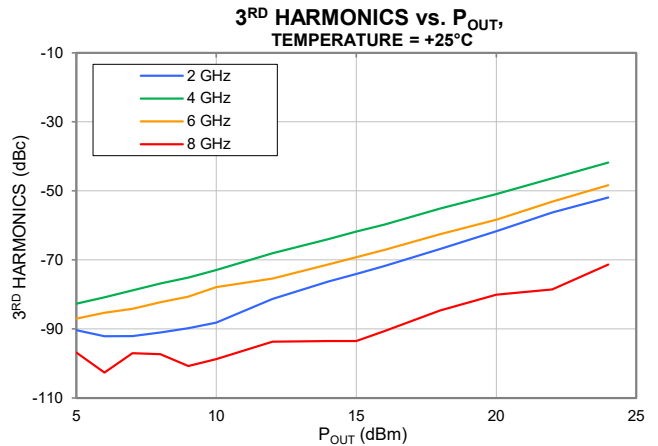
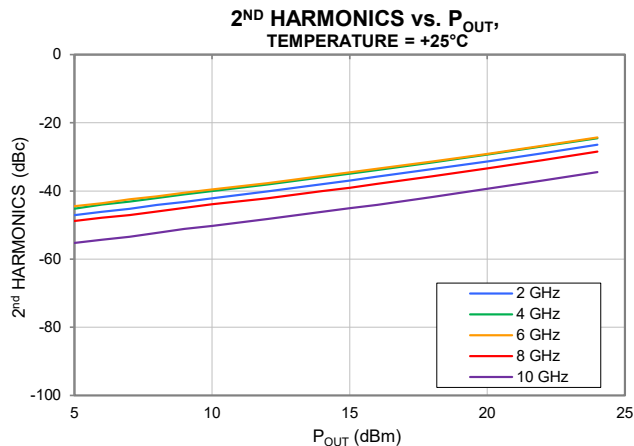
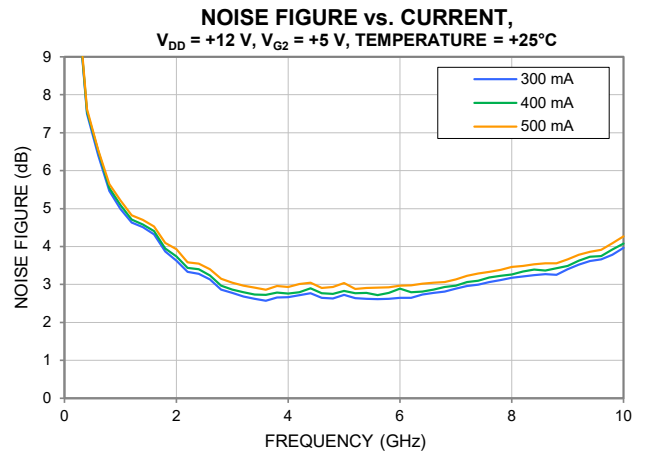
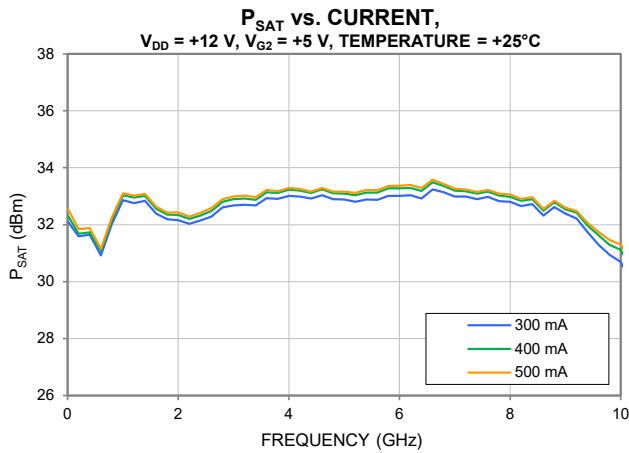
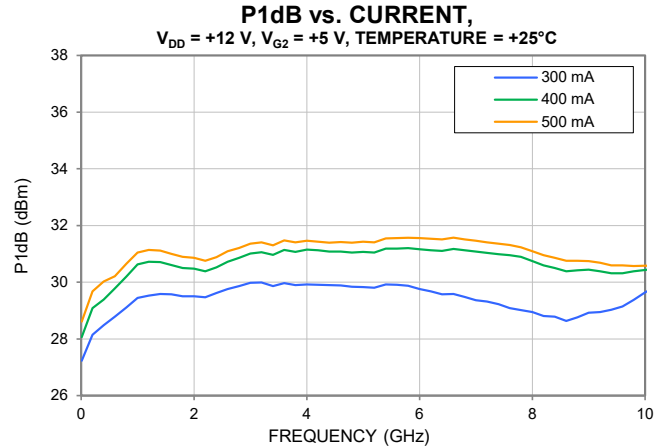
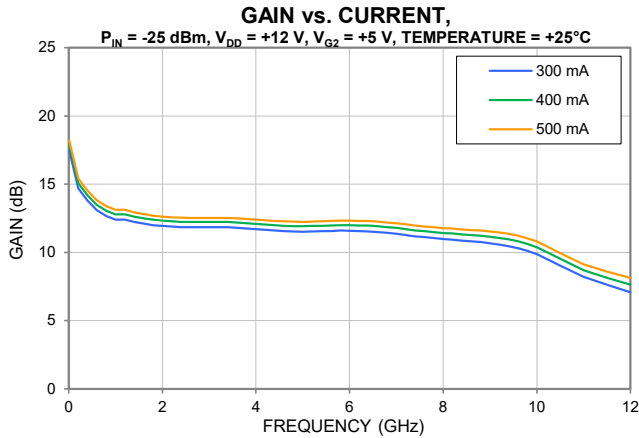



MMIC SURFACE MOUNT

Power Amplifier

PMA5-83-2W+

Mini-Circuits

50 Ω 0.01 to 10 GHz 2 W P_{SAT}

ABSOLUTE MAXIMUM RATINGS⁶

Parameter	Ratings
Operating Temperature (ground lead)	-45°C to +85°C
Storage Temperature	-65°C to +150°C
Junction Temperature ⁷	+175°C
Total Power Dissipation	10 W
Input Power (CW), V _{DD} = +12 V	+31 dBm
DC Voltage at RF-OUT + V _{DD}	+16.5 V
DC Gate Voltage at V _{G1}	-0.2 V
DC Gate Voltage at V _{G2}	+7.5 V
DC Gate Current at V _{G1} (I _{G1})	4.5 mA
DC Gate Current at V _{G2} (I _{G2})	4.5 mA

6. Permanent damage may occur if any of these limits are exceeded. Maximum ratings are not intended for continuous normal operation.

7. Peak temperature on top of Die.

THERMAL RESISTANCE

Parameter	Ratings
Thermal Resistance (Θ _{jc}) ⁸	6°C/W

8. Θ_{jc} = (Hot Spot Temperature on Die - Temperature at Ground Lead)/Dissipated Power

ESD RATING

	Class	Voltage Range	Reference Standard
HBM	1A	250 V to <500 V	ANSI/ESDA/JEDEC JS-001-2017
CDM	C2	500 V to <1,000 V	JESD22-C101F



ESD HANDLING PRECAUTION: This device is designed to be Class 1A for HBM. Static charges may easily produce potentials higher than this with improper handling and can discharge into DUT and damage it. As a preventive measure Industry standard ESD handling precautions should be used at all times to protect the device from ESD damage.

MSL RATING

Moisture Sensitivity: MSL1 in accordance with IPC/JEDEC J-STD-020E/JEDEC J-STD-033C





MMIC SURFACE MOUNT

Power Amplifier

PMA5-83-2W+

Mini-Circuits

50 Ω 0.01 to 10 GHz 2 W P_{SAT}

FUNCTIONAL DIAGRAM

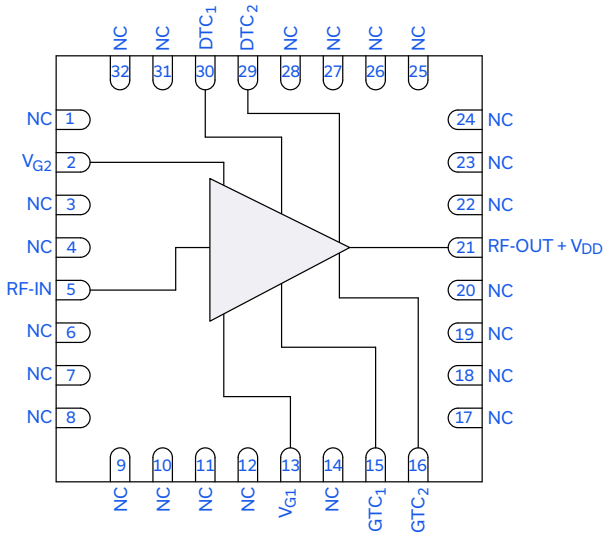

Figure 1. PMA5-83-2W+ Functional Diagram

PAD DESCRIPTION

Function	Pad Number	Description (Refer to Figure 2)
RF-IN	5	RF-IN Pad connects to RF Input port.
RF-OUT & V _{DD}	21	RF-OUT Pad connects to RF Output port. V _{DD} is applied via external bias tee.
V _{G1}	13	Gate 1 control voltage.
V _{G2}	2	Gate 2 control voltage.
DTC ₁	30	Drain Low Frequency Termination Capacitor (AC GND)
DTC ₂	29	Drain Low Frequency Termination Capacitor (AC GND)
GTC ₁	15	Gate Low Frequency Termination Capacitor (AC GND)
GTC ₂	16	Gate Low Frequency Termination Capacitor (AC GND)
NC	1, 3, 4, 6-12, 14, 17-20, 22-28, 31, 32	Not used internally. Connected to ground on test board.
GND	Paddle	Connects to ground.

CHARACTERIZATION TEST BOARD

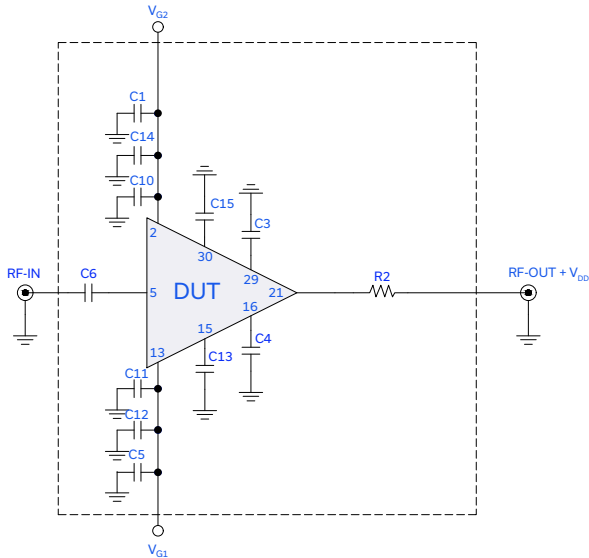

Figure 2. DUT soldered on Mini-Circuits Characterization Test Board

Electrical Parameters and Conditions

Gain, Return Loss, Output Power at 1 dB Compression (P1dB), Output IP3 (OIP3), and Noise Figure measured using N5242B PNA-X Microwave Network Analyzer. Device bias voltage V_{DD} supplied by external Bias-Tee.

Conditions:

1. Gain and Return Loss: P_{IN} = -25 dBm
2. Output IP3 (OIP3): Two tones, spaced 1MHz apart, +20 dBm/Tone at output.

Power ON/ Power OFF Sequence

Caution: Permanent damage to the device will occur if the Power ON/ Power OFF sequences are not followed.

Power ON:

1. Set V_{G1} = -2 V and Turn ON.
2. Set V_{G2} = +5 V and Turn ON.
3. Set V_{DD} = +12 V and Turn ON.
4. Increase V_{G1} to desired I_{DD}.
5. Turn ON RF signal.

Power OFF:

1. Turn OFF RF signal.
2. Decrease V_{G1} to -2 V.
3. Turn OFF V_{DD}.
4. Turn OFF V_{G2}.
5. Turn OFF V_{G1}.

Component	Value	Size	Part Number	Manufacturer
R2	0Ω	0402	RK73Z1ETTP	KOA SPEER ELECTRONICS
C1, C3, C4, C5	4.7 μF	1206	12063C475KAT2A	AVX CORPORATION
C6	0.1 μF	0402	GRM155R71E104KE14D	MURATA
C10, C11	100 pF	0402	GRM1555C1H101JA01D	MURATA
C12, C13, C14, C15	1 nF	0402	GRM1555C1H102JA01D	MURATA





EVALUATION BOARD

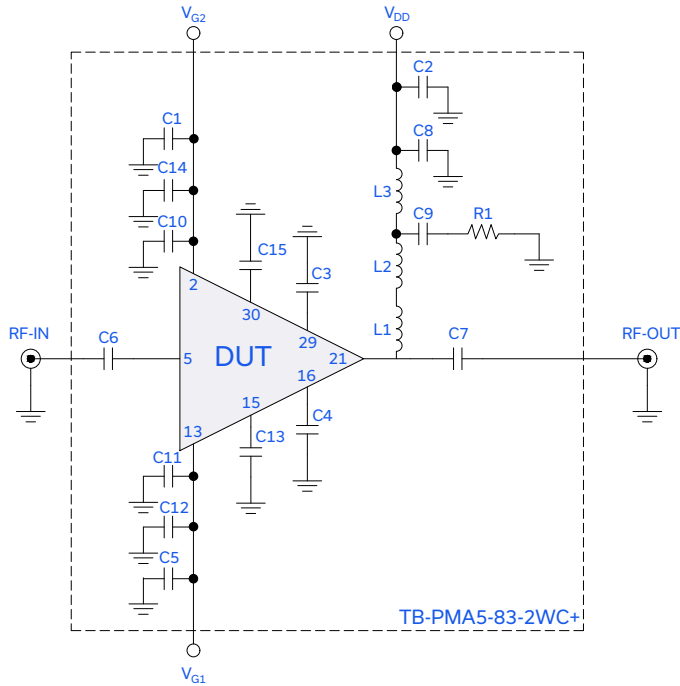

Power ON/ Power OFF Sequence

Caution: Permanent damage to the device will occur if the Power ON/ Power OFF sequences are not followed.

Power ON:

1. Set $V_{G1} = -2$ V and Turn ON.
2. Set $V_{G2} = +5$ V and Turn ON.
3. Set $V_{DD} = +12$ V and Turn ON.
4. Increase V_{G1} to desired I_{DD} .
5. Turn ON RF signal.

Power OFF:

1. Turn OFF RF signal.
2. Decrease V_{G1} to -2 V.
3. Turn OFF V_{DD} .
4. Turn OFF V_{G2} .
5. Turn OFF V_{G1} .

Figure 3. DUT soldered on Mini-Circuits Evaluation Board TB-PMA5-83-2WC+

Component	Value	Size	Part Number	Manufacturer
R1	301Ω	0402	RK73H1ETTP3010F	KOA SPEER ELECTRONICS
C1, C2, C3, C4, C5	4.7 μF	1206	12063C475KAT2A	AVX CORPORATION
C6, C7, C8	0.1 μF	0402	GRM155R71E104KE14D	MURATA
C9, C10, C11	100 pF	0402	GRM1555C1H101JA01D	MURATA
C12, C13, C14, C15	1 nF	0402	GRM1555C1H102JA01D	MURATA
L1, L2	36 nH	0402	0402AF-360XJLW	COILCRAFT
L3	1.1 μH	1008	1008AF-112XKRC	COILCRAFT



MMIC SURFACE MOUNT

Power Amplifier

PMA5-83-2W+

Mini-Circuits

50 Ω 0.01 to 10 GHz 2 W P_{SAT}

CASE STYLE DRAWING

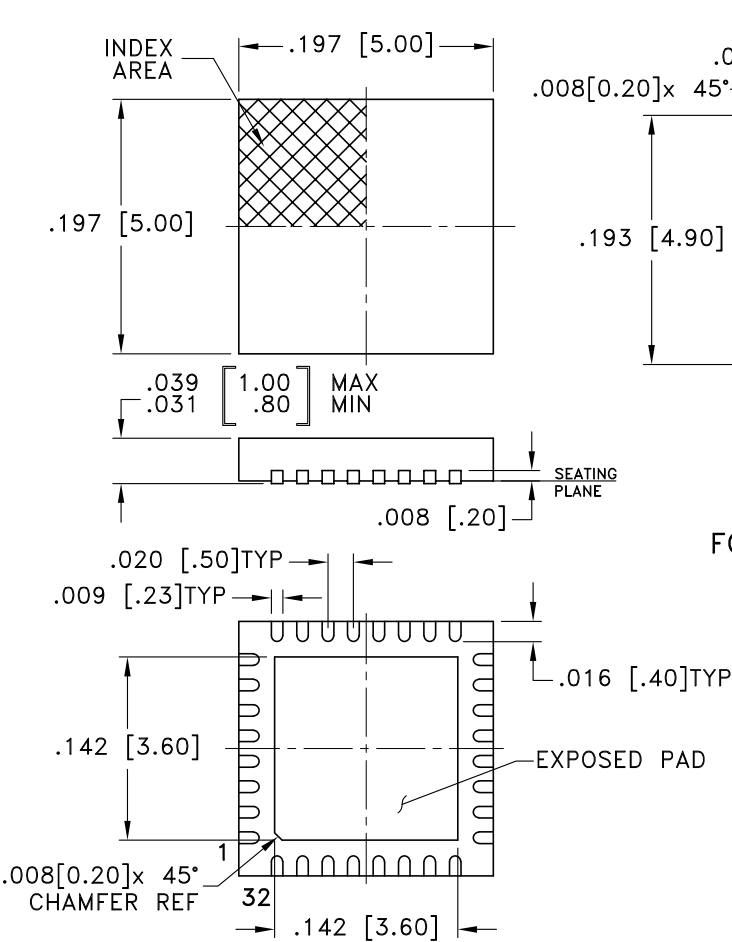

PCB Land Pattern

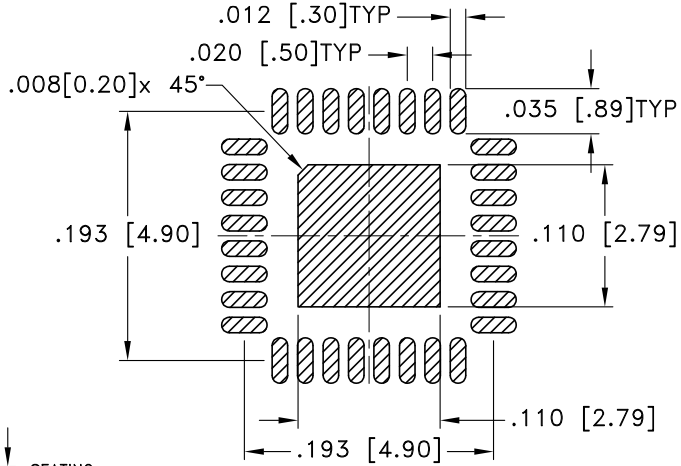

SUGGESTED LAYOUT FOR PCB LAND PATTERN (TOL ±.002)

Weight: .05 grams

Dimensions are in inches [mm]. Tolerances: 2 Pl.±.01; 3Pl.±.005 Inch

PRODUCT MARKING

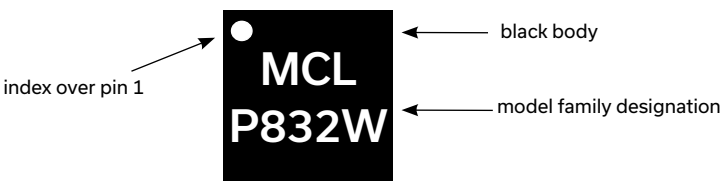

Marking may contain other features or characters for internal lot control



MMIC SURFACE MOUNT

Power Amplifier

PMA5-83-2W+

50 Ω 0.01 to 10 GHz 2 W P_{SAT}

ADDITIONAL DETAILED INFORMATION IS AVAILABLE ON OUR DASH BOARD [CLICK HERE](#)

Performance Data & Graphs	Data
	Graphs
	S-Parameter (S2P Files) Data Set (.zip file)
Case Style	DG1677-10 Plastic package, exposed paddle, Lead Finish: Matte-Tin
RoHS Status	Compliant
Tape & Reel	F68-1
Standard quantities available on reel	7" reels with 10, 50, 100, 200, 500, 1K, or 2K devices
Suggested Layout for PCB Design	PL-771
Evaluation Board	TB-PMA5-83-2WC+
	Gerber File
Environmental Ratings	ENV08T1

NOTES

- A. Performance and quality attributes and conditions not expressly stated in this specification document are intended to be excluded and do not form a part of this specification document.
- B. Electrical specifications and performance data contained in this specification document are based on Mini-Circuit's applicable established test performance criteria and measurement instructions.
- C. The parts covered by this specification document are subject to Mini-Circuits standard limited warranty and terms and conditions (collectively, "Standard Terms"); Purchasers of this part are entitled to the rights and benefits contained therein. For a full statement of the standard terms and the exclusive rights and remedies thereunder, please visit Mini-Circuits' website at www.minicircuits.com/terms/viewterm.html

