



COAXIAL NON-ISOLATING

Power Splitter/Combiner

COM-2G42G51K0+

50Ω 4-Way-0° 2.4 to 2.5 GHz N type Female to 7/16 DIN Female 1200W

THE BIG DEAL

- Very high-power handling, up to 1200W CW
- Exceptionally low insertion loss, 0.1dB typ.
- Low amplitude (0.15dB typ.) and phase unbalance (1° typ.)
- Patent Pending



Generic photo used for illustration purposes only

APPLICATIONS

- RF energy generators
- Industrial heating
- Plasma generators
- S-band high-power amplifiers

FUNCTIONAL DIAGRAM

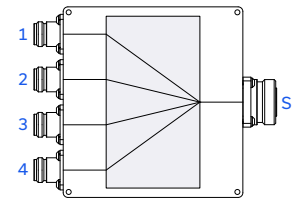

PRODUCT OVERVIEW

Mini-Circuits' COM-2G42G51K0+ is a 4-way 0° non-isolating combiner providing very high power handling and exceptionally low insertion loss across 2400 to 2500 MHz. It is designed to maximize the efficiency of high-power amplifiers and generators working in the ISM 2.45GHz band and a variety of other S-band applications.

KEY FEATURES

Features	Advantages
Non-Isolating Combiner	The COM-2G42G51K0+ is a non-isolating combiner (i.e. no internal isolating resistors). All performance parameters, when used as a combiner, are based upon all 4 input ports fed with coherent signals and 50 ohm impedances
Power handling up to 1.2kW	This makes COM-2G42G51K0+ suitable for high-power SSPA application
Low insertion loss, 0.1dB	Low insertion loss results in low power dissipation and easy thermal management, high power combining efficiency
Optimized distribution of electrical, thermal and mechanical stress	Excellent ruggedness and long-term reliability
Low amplitude unbalance (0.15dB typ.) and phase imbalance (1° typ.)	High power combining efficiency. Precise signal distribution when used as the splitter

REV. OR
ECO-017143
COM-2G42G51K0+
MCL NY
230329





COAXIAL NON-ISOLATING

Power Splitter/Combiner

COM-2G42G51K0+

Mini-Circuits

50Ω 4-Way-0° 2.4 to 2.5 GHz N type Female to 7/16 DIN Female 1200W

ELECTRICAL SPECIFICATIONS AT $T_{CASE} = 25^{\circ}C$

Parameter	Frequency (MHz)	Min.	Typ.	Max.	Units
Frequency Range	-	2400	-	2500	MHz
Insertion Loss (above 6 dB) ¹	2400-2500	-	0.1	0.3	dB
Phase Unbalance (\pm) ²	2400-2500	-	1	5	Degree
Amplitude Imbalance (\pm) ²	2400-2500	-	0.15	0.3	dB
VSWR (Port S)	2400-2500	-	1.1	1.22	:1
Power Handling ¹	As Splitter ^{2,4}	2400-2500	-	1200	W
	As Combiner ^{3,4}	2400-2500	-	1200	

1. All 4 ports are fed with coherent input signals when used as combiner, for derating vs temperature and VSWR, see graph below
2. All ports must be terminated with 50 Ω .
3. As a combiner of coherent signals, max. power per port is 300W.

POWER DERATING CURVE

Power Derating⁴ vs Temperature

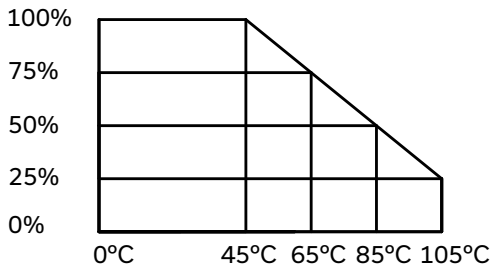

Power Derating⁴ vs VSWR

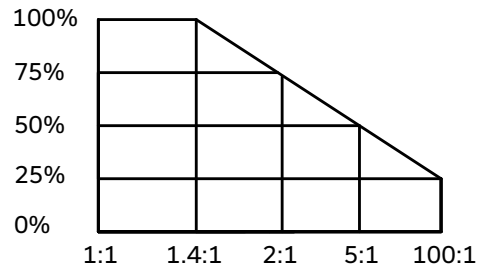

4. Power derating chart is based on units operated in CW mode

ABSOLUTE MAXIMUM RATINGS⁵

Parameter	Ratings
Operating Case Temperature ⁶	0 °C to +105 °C
Storage Temperature	0 °C to +105 °C

5. Permanent damage may occur if any of these limits are exceeded.
 6. Units can be operated up to 105°C. Please refer to power derating chart.



COAXIAL NON-ISOLATING

Power Splitter/Combiner

COM-2G42G51K0+

Mini-Circuits

50Ω 4-Way-0° 2.4 to 2.5 GHz N type Female to 7/16 DIN Female 1200W

TYPICAL PERFORMANCE DATA ACROSS FREQUENCY ($T_{CASE} = +25^{\circ}C$, 50Ω SYSTEM)

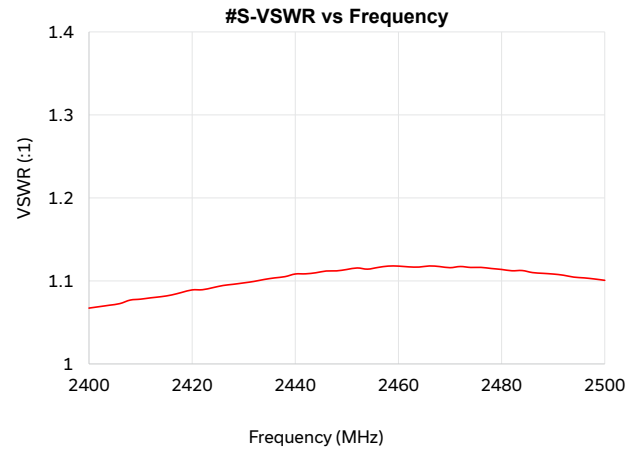
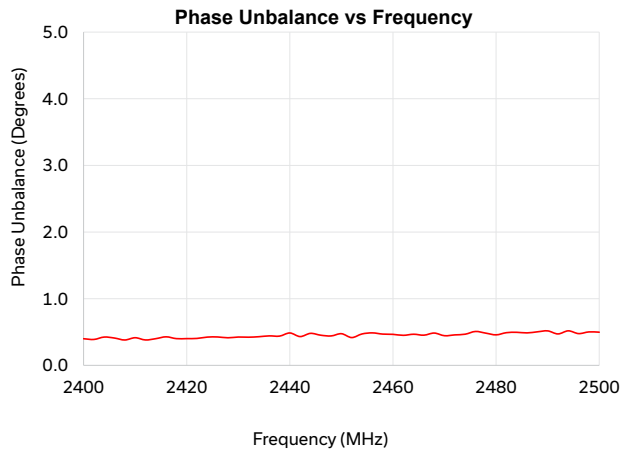
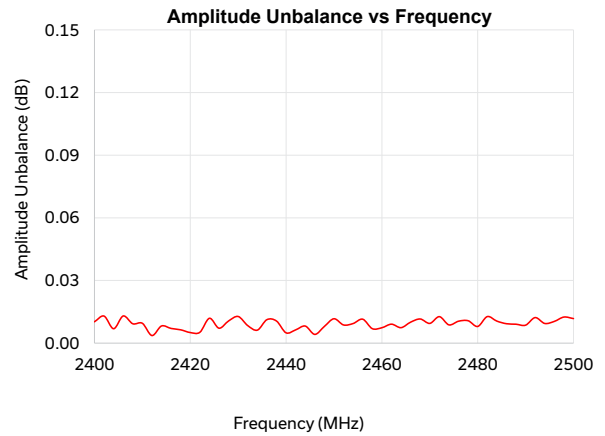



COAXIAL NON-ISOLATING

Power Splitter/Combiner

COM-2G42G51K0+

Mini-Circuits

50Ω 4-Way-0° 2.4 to 2.5 GHz N type Female to 7/16 DIN Female 1200W

COAXIAL CONNECTIONS

(Port 1,2,3,4)	N type Female
(Port S)	7/16 DIN Female

CASE STYLE DRAWING

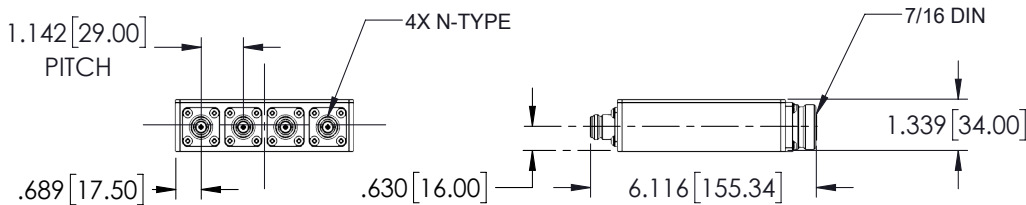
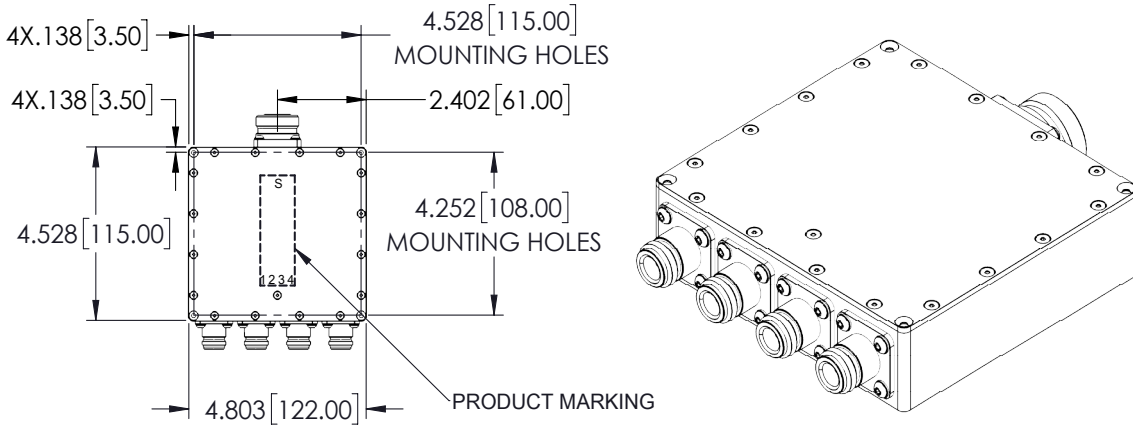

Weight: 875.5 grams

Dimensions are in inches [mm]. Tolerances: 2 Pl. 0.01inch; 3 Pl. 0.005 inch

PRODUCT MARKING*: COM-2G42G51K0+

*Marking may contain other features or characters for internal lot control.

ADDITIONAL INFORMATION IS AVAILABLE ON OUR DASHBOARD

[CLICK HERE](#)

Performance	Data
	Graphs
	S-Parameter (S5P Files) Data Set (.zip file)
Case Style	VU3413
RoHs Status	Compliant
Environmental Ratings	ENV28T21

NOTES

- A. Performance and quality attributes and conditions not expressly stated in this specification document are intended to be excluded and do not form a part of this specification document.
- B. Electrical specifications and performance data contained in this specification document are based on Mini-Circuit's applicable established test performance criteria and measurement instructions.
- C. The parts covered by this specification document are subject to Mini-Circuits standard limited warranty and terms and conditions (collectively, "Standard Terms"); Purchasers of this part are entitled to the rights and benefits contained therein. For a full statement of the standard terms and the exclusive rights and remedies thereunder, please visit Mini-Circuits' website at www.minicircuits.com/terms/viewterm.html

