



LTCC SURFACE MOUNT

# Bandpass Filter

## BFHKI-7851+

50Ω 6.7 to 8.6 GHz

### THE BIG DEAL

- LTCC Band Pass Filter with Integrated Interposer Board
- Wide Stopband Rejection, Typ. 42dB up to 18.5GHz
- Shielded Construction
- Protected by US Patents 11,638,370 and 11,744,057



Generic photo used for illustration purposes only

### APPLICATIONS

- Test & Measurement Equipment
- Radar
- SATCOM
- Point-to-Point Radios

### FUNCTIONAL DIAGRAM

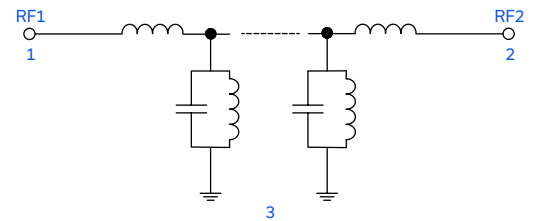

### PRODUCT OVERVIEW

BFHKI-7851+ is a miniature low temperature co-fired ceramic (LTCC) ultra-high stopband rejection band pass filter with a 6.7 to 8.6GHz passband that supports a variety of applications. This model achieves 42dB typical stopband rejection up to 18.5GHz, when mounted on coplanar waveguide layouts. Housed in a small 4.95mm by 3.65mm ceramic form factor, the filter is ideal for dense signal chain PCB layouts where it complements MMIC size and performance. The BFHKI family with integrated interposer board enables installation onto PCB layouts with automated manufacturing equipment. This model provides 3.4dB typical insertion loss over a wide band due to its rugged monolithic construction. The LTCC fabrication process assures minimal RF performance variation while delivering a product that is well suited for environmental extremes of high humidity and temperature.

### KEY FEATURES

Features	Advantages
Surface mountable due to Integrated Interposer Board	Enables installation with automated manufacturing equipment making this suitable for high-volume processes.
Wide Rejection	Provides high stopband rejection of 42dB typical up to 18.5GHz.
Small Size (4.95 x 3.65mm)	Allows for high layout density of circuit boards, while minimizing effects of parasitics.
Wide Operating and Storage Temperature (-55 to 125°C)	Enables use in high reliability and extreme environment conditions, such as in aerospace & defense applications.
Cost Effective	LTCC is a scalable technology that is cost effective due to ease of production in high-volume.

REV. A  
ECO-019173  
BFHKI-7851+  
MCL NY  
231020





LTCC SURFACE MOUNT

# Bandpass Filter

## BFHKI-7851+

50Ω 6.7 to 8.6 GHz

### ELECTRICAL SPECIFICATIONS<sup>1,2,3</sup> AT +25°C

Parameter	F#	Frequency (GHz)	Min.	Typ.	Max.	Units	
Passband	Center Frequency <sup>4</sup>	—	—	7.7	—	GHz	
	Insertion Loss	F2-F3	6.7 - 8.6	—	3.4	4.7	dB
	Return Loss	F2-F3	6.7 - 8.6	—	13	—	dB
Stop Band, Lower	Rejection	DC-F1	0.1 - 4.6	60	70	—	dB
Stop Band, Upper	Rejection	F4-F5	10.9 - 16.5	40	50	—	dB
			16.5 - 18.5	32	42	—	dB

1. Tested on Evaluation Board P/N TB-BFHKI-7851C+. Measured with the connector and feedline effects de-embedded using the 2XThru IEEE P370 method.

2. Bi-directional RF1 and RF2 ports can be interchanged.

3. This component should not be used as a DC-block. In applications where DC voltage and/or current is present at either the input or output ports, external DC blocking capacitors are required.

4. Typical variation ±4%

### ABSOLUTE MAXIMUM RATINGS<sup>5</sup>

Parameter	Ratings
Operating Temperature	-55°C to +125°C
Storage Temperature	-55°C to +125°C
Input Power <sup>6</sup>	1W

5. Permanent damage may occur if any of these limits are exceeded.

6. Power rating applies only to signals within the passband. Power rating above +25°C operating temperature decreases linearly to 0.5W at +125°C.

### TYPICAL FREQUENCY RESPONSE AT +25°C

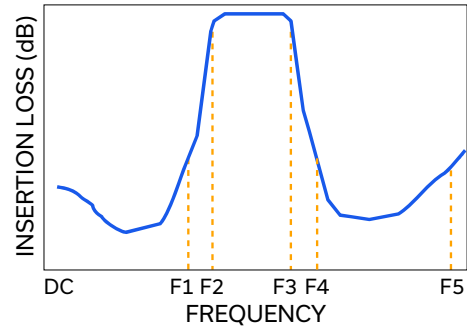



LTCC SURFACE MOUNT

# Bandpass Filter

**BFHKI-7851+**

Mini-Circuits

50Ω 6.7 to 8.6 GHz

## TYPICAL PERFORMANCE GRAPHS AT +25°C

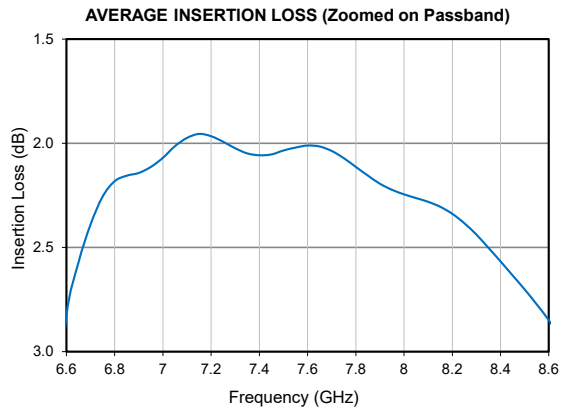
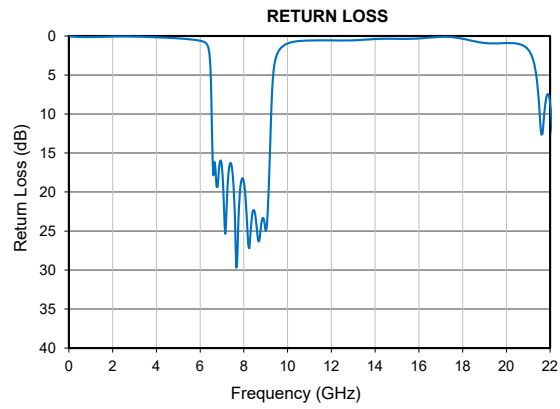
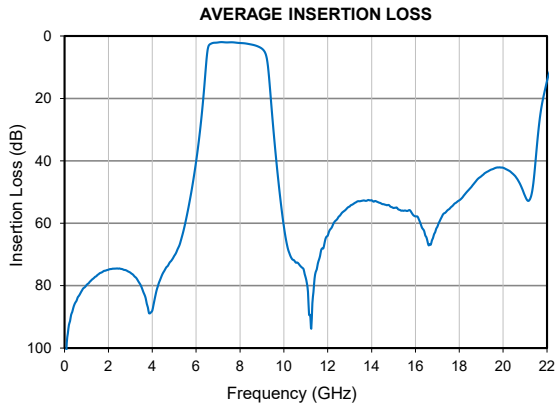



### FUNCTIONAL DIAGRAM

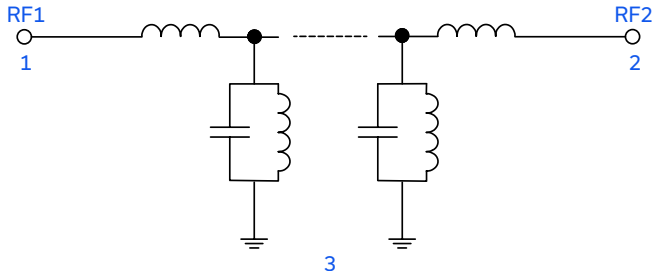
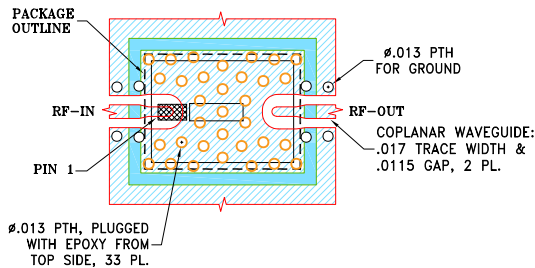

Figure 1. BFHKI-7851+ Functional Diagram

### PAD DESCRIPTION

Function	Pad Number	Description
RF1 <sup>2</sup>	1	Connects to RF Input Port
RF2 <sup>2</sup>	2	Connects to RF Output Port
GROUND	3	Connects to Ground on PCB, (See drawing PL-753)

### SUGGESTED PCB LAYOUT (PL-753)



#### NOTES:

- TRACE WIDTH & GAP PARAMETERS ARE SHOWN FOR ROGERS R04350B WITH DIELECTRIC THICKNESS .010"; COPPER: 1/2 OZ. FOR OTHER MATERIALS TRACE WIDTH AND GAP MAY NEED TO BE MODIFIED.
- BOTTOM SIDE OF THE PCB ARE CONTINUOUS GROUND PLANE.

- DENOTES PCB COPPER LAYOUT WITH SMOBC (SOLDER MASK OVER BARE COPPER)
- DENOTES COPPER LAND PATTERN FREE OF SOLDER MASK

Figure 2. Suggested PCB Layout BFHKI-7851+

### CASE STYLE DRAWING

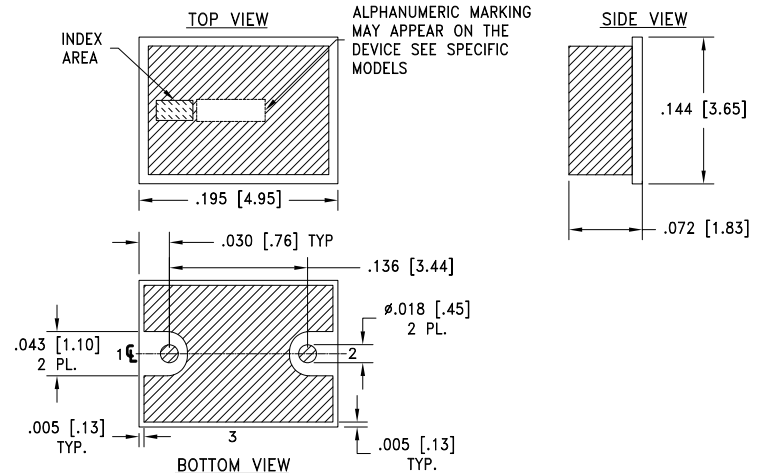

METALLIZATION

Weight: .135 grams.

Dimensions are in inches [mm]. Tolerances: 2 PL. ±.01; 3 PL. ±.005

### PRODUCT MARKING\*: F477

\*Marking may contain other features or characters for internal lot control.



LTCC SURFACE MOUNT

# Bandpass Filter

## BFHKI-7851+

Mini-Circuits

50Ω 6.7 to 8.6 GHz

ADDITIONAL DETAILED INFORMATION IS AVAILABLE ON OUR DASH BOARD.

[CLICK HERE](#)

Performance Data & Graphs	Data Graphs S-Parameter (S2P Files) Data Set (.zip file) De-embedded to device pads
Case Style	NM3237 Finish: Gold over Nickel Plating
RoHS Status	Compliant
Tape and Reel	TR-F77
Suggested Layout for PCB Design	PL-753
Evaluation Board	TB-BFHKI-7851C+ Gerber File
Environmental Rating	ENV06T12

### NOTES

- A. Performance and quality attributes and conditions not expressly stated in this specification document are intended to be excluded and do not form a part of this specification document.
- B. Electrical specifications and performance data contained in this specification document are based on Mini-Circuits' applicable established test performance criteria and measurement instructions.
- C. The parts covered by this specification document are subject to Mini-Circuits' standard limited warranty and terms and conditions (collectively, "Standard Terms"); Purchasers of this part are entitled to the rights and benefits contained therein. For a full statement of the standard terms and the exclusive rights and remedies thereunder, please visit Mini-Circuits' website at [www.minicircuits.com/terms/viewterm.html](http://www.minicircuits.com/terms/viewterm.html)

