



THIN FILM SURFACE MOUNT

Low Pass Filter

ALF-6000+

50Ω DC to 6GHz

KEY FEATURES

- Low Passband Insertion Loss of 0.7dB Typ.
- High Rejection of 38dB Typ.
- Good Return Loss of 16dB Typ.
- Small Size, 5.59 x 8.13 x 2.03 mm

APPLICATIONS

- Harmonic Rejection
- VHF/UHF Transmitters/Receivers.
- Test and Measurement Equipment.

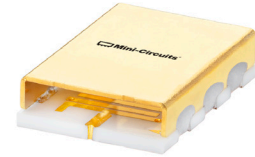

Generic photo used for illustration purposes only

PRODUCT OVERVIEW

Mini-Circuits' Surface Mount Thin-Film filters offer low insertion loss and high rejection realized via Thin-Film on Alumina substrate, using a sputtering process that can guarantee an enhanced Q and repeatable performance. Low pass, high pass, and bandpass surface mount thin-film designs can be realized with this technology up to 40GHz in a small form factor helping customers achieve their SWaP objectives. Using our high quality thin-film manufacturing process we can guarantee repeatability on large batches of filters.

FUNCTIONAL DIAGRAM

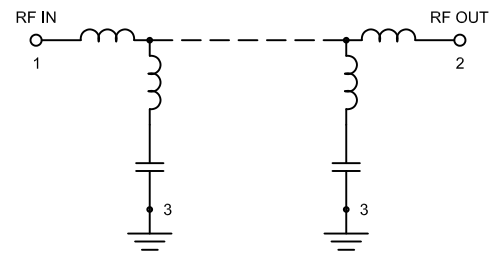

ELECTRICAL SPECIFICATIONS^{1,2} AT +25°C

Parameter		F#	Frequency (GHz)	Min.	Typ.	Max.	Units
Pass Band	Insertion Loss	DC-F1	DC - 6	—	0.7	1.2	dB
	Freq. Cut-Off ³	Fc	6.93	—	3.0	—	dB
	Return Loss	DC-F1	DC - 6	—	16	—	dB
Stop Band	Rejection	F2-F3	8.2 - 9.4	25	37	—	dB
		F3-F4	9.4 - 13	32	37	—	
		F4-F5	13 - 14	—	38	—	
		F5-F6	14 - 15.5	—	15	—	

1. Tested in Evaluation Board P/N TB-ALF-6000+ with feedline losses removed by normalization of S12 and S21 traces to measurement of TB thru-line.

2. This filter is bi-directional RF1 and RF2 ports may be interchanged, see S-Parameters for actual performance.

3. Typical variation ±3%

ABSOLUTE MAXIMUM RATINGS⁴

Parameter	Ratings
Operating Temperature	-55 °C to +125 °C
Storage Temperature	-55 °C to +125 °C
Input Power ⁵	15 Max. at 25°C

4. Permanent damage may occur if any of these limits are exceeded.

5. Power rating applies only to signals within the passband.

TYPICAL FREQUENCY RESPONSE

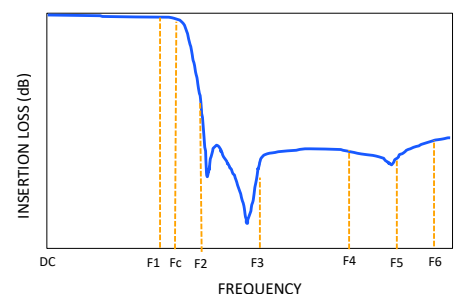



THIN FILM SURFACE MOUNT

Low Pass Filter

ALF-6000+

Mini-Circuits

50Ω DC to 6GHz

TYPICAL PERFORMANCE GRAPHS AT +25°C

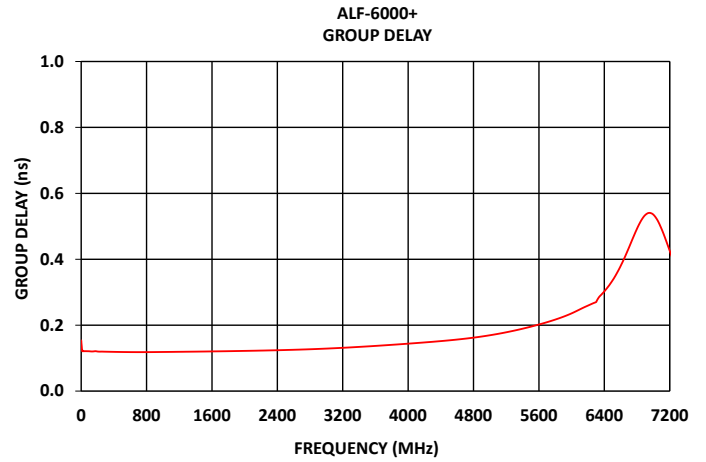
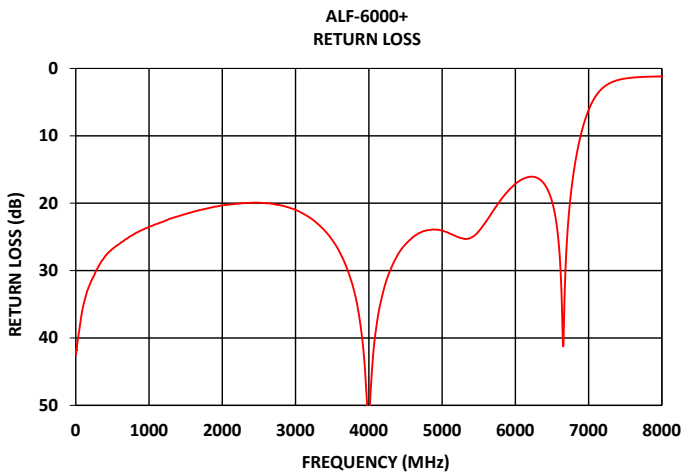
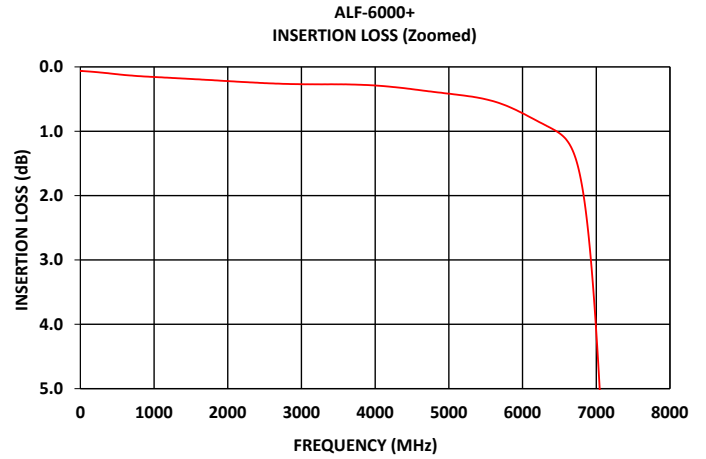
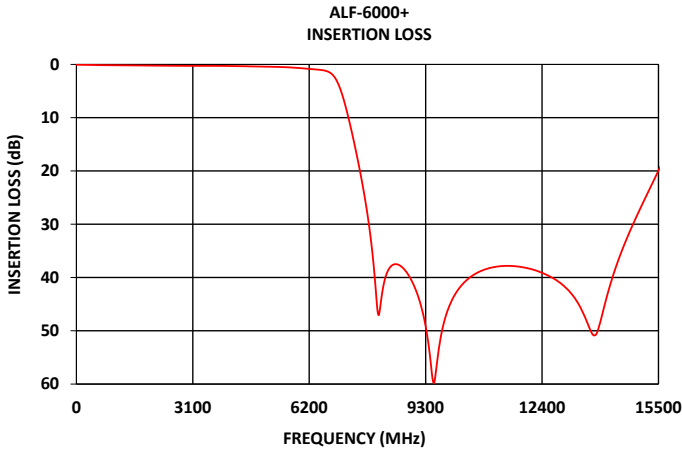



FUNCTIONAL DIAGRAM

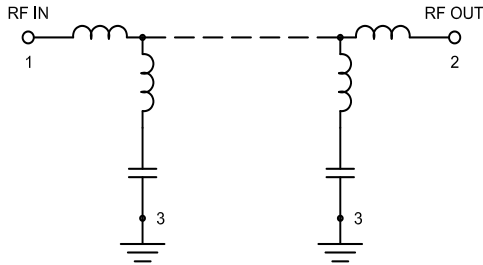
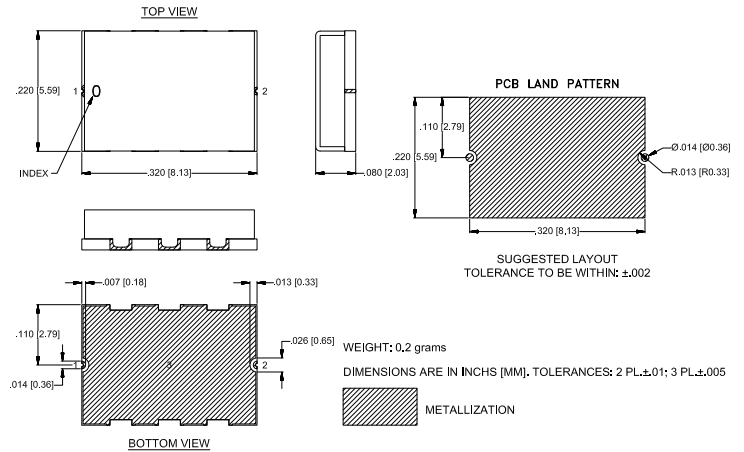

Figure 1. ALF-6000+ Functional Diagram

PAD DESCRIPTION

Function	Pad Number	Description
RF1 ²	1	Connects to RF Input Port
RF2 ²	2	Connects to RF Output Port
GROUND	3	Connects to Ground on PCB, (See drawing PL-764)
NC	—	No connection, not used internally. See drawing PL-764 for connection to PCB

CASE STYLE DRAWING



SUGGESTED PCB LAYOUT (PL-764)

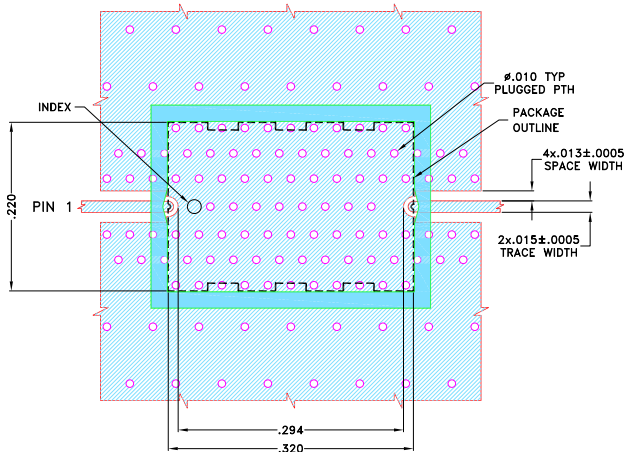

NOTES:

1. COPLANAR WAVEGUIDE PARAMETERS ARE SHOWN FOR ROGERS (RO4350B Lo Pro) WITH DIELECTRIC THICKNESS .0073±.0007. COPPER: 1/2 Oz. EACH SIDE. FOR OTHER MATERIALS TRACE WIDTH AND GAP MAY NEED TO BE MODIFIED.
 2. BOTTOM SIDE OF THE PCB IS CONTINUOUS GROUND PLANE.
- DENOTES PCB COPPER PATTERN WITH SMOBC (SOLDER MASK OVER BARE COPPER)
 ■ DENOTES PCB COPPER PATTERN FREE OF SOLDERMASK

Figure 2. Suggested PCB Layout PL-764

PRODUCT MARKING*: ALF-6000

*Marking may contain other features or characters for internal lot control.



RECOMMENDED PCB LAYOUT PATTERN FOR FILTER

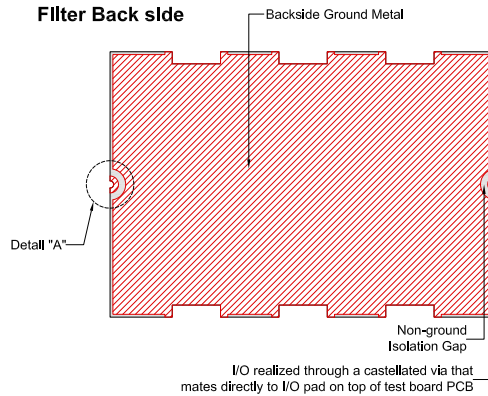

Filter RF I/O Detail (Filter Back Side)

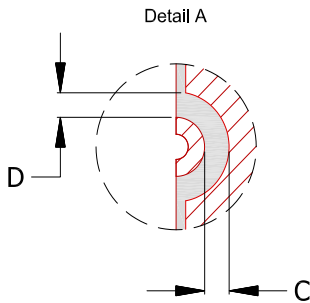

PCB Pattern Recommendations

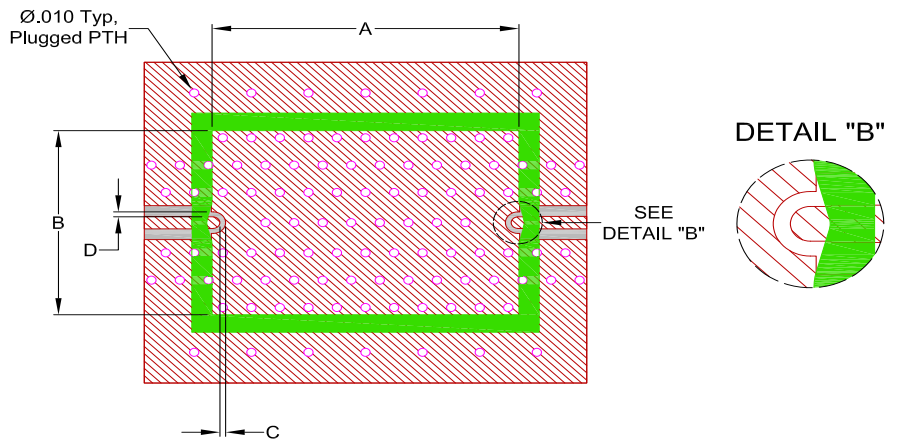

- 1) Customer PCB's ground pattern length (dimension A) can be similar to filter length.
- 2) Customer PCB's ground pattern width (dimension B) can be similar filter width.
- 3) Dimensions C and D on Filter RF I/O detail and Customer PCB pattern can be closely match. The dimensions of C and D on the Customer PCB pattern can be slightly larger to account for component alignment tolerance (ground metal can be pulled back from RF I/O trace).
- 4) Recommend to use Solder mask at Customer PCB at outer area of filter pattern/ footprint with a clearance of about 1.25mil at each side. (Tighter registration tolerance required for solder mask)
- 5) Recommended to use Solder mask at I/O of Customer PCB as per above diagram (refer detail B).



COMMENTS ON COMPONENT HANDLING AND SOLDER ATTACH

- 1) Avoid using soldering iron directly to the ceramic filter. This would lead to development of crack in the component due to thermal shock.
- 2) Vacuum pick-up tool or plastic tweezers are recommended for handling the components. Extra care should be taken not to scratch the filter or metal area.
- 3) Use 2-3 mil thickness stencil plate and screen print the solder. Refer below picture for recommended stencil pattern to get the best solder attachment.

Stencil opening drawing

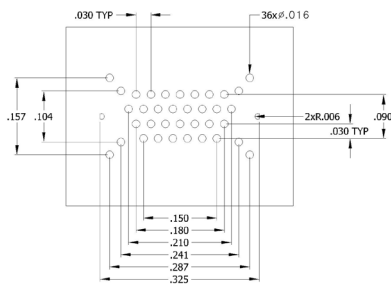

Solder location after screen print

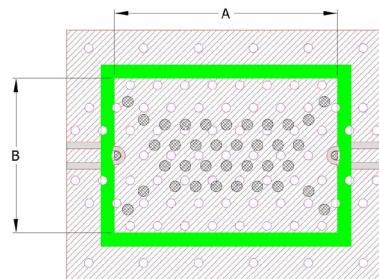

- 4) Plugged ground vias in the PWB will improve attachment consistency.
- 5) Recommended to have a similar or closer test board material and thickness (refer Mini-Circuits evaluation board for details) to minimize the CTE over the temperature range.



THIN FILM SURFACE MOUNT

Low Pass Filter

ALF-6000+

Mini-Circuits

50Ω DC to 6GHz

ADDITIONAL DETAILED INFORMATION IS AVAILABLE ON OUR DASH BOARD.

[CLICK HERE](#)

Performance Data and Graphs	Data
	Graphs
	S-Parameter (S2P Files) Data Set (.zip file) De-embedded to device pads
Case Style	UC2731 Lead Finish: Gold over Nickel Plate.
RoHS Status	Compliant
Tape and Reel	TR-F003
Suggested Layout for PCB Design	PL-764
Evaluation Board	TB-ALF-6000+
	Gerber File
Environmental Rating	ENV120

NOTES

- A. Performance and quality attributes and conditions not expressly stated in this specification document are intended to be excluded and do not form a part of this specification document.
- B. Electrical specifications and performance data contained in this specification document are based on Mini-Circuits' applicable established test performance criteria and measurement instructions.
- C. The parts covered by this specification document are subject to Mini-Circuits' standard limited warranty and terms and conditions (collectively, "Standard Terms"); Purchasers of this part are entitled to the rights and benefits contained therein. For a full statement of the standard terms and the exclusive rights and remedies thereunder, please visit Mini-Circuits' website at www.minicircuits.com/terms/viewterm.html

