

Evaluation Board and Circuit

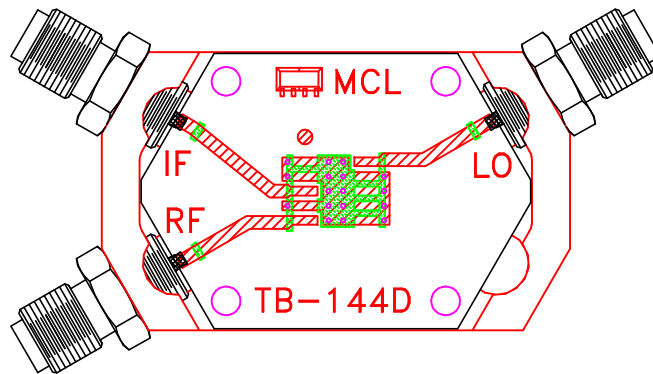

TB-144

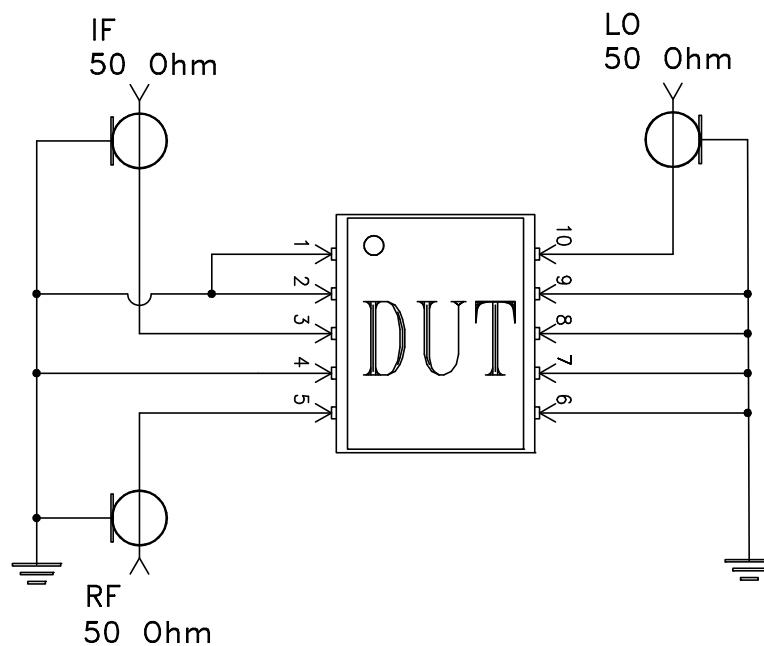

Schematic Diagram

Notes:

1. SMA Female connectors.
2. PCB Material: Rogers R04350 or equivalent,
Dielectric Constant=3.5, Thickness=.020 inch.

 **Mini-Circuits®**