

Flattening Negative Gain Slope with MMIC Fixed Equalizers

AN-60-106

I. Introduction

Equalizers are devices used to compensate for negative gain slope in the frequency response of a wide variety of RF systems. Unlike a standard attenuator with a flat frequency response, an equalizer is a unique kind of attenuator which exhibits lower insertion loss as frequency increases with some known slope. This is a useful characteristic for system designers working in wideband applications where the gain response of circuit elements or of the entire RF chain often varies across frequency.

For example, an 8 dB fixed slope equalizer may be cascaded with an amplifier that exhibits a negative 8 dB gain slope to flatten the amplifier gain response (Figure 1a). Likewise, an amplifier may also be paired with an equalizer of a greater dB slope value to create a net positive gain slope response (Figure 1b). This technique is sometimes used to compensate for the cascaded effects of other elements in the RF chain and achieve a flatter overall system gain slope.

To illustrate their functionality, this application note explores how equalizers are used specifically to compensate for negative gain slope in wideband amplifiers. The different types of equalizers and their various characteristics are reviewed, a case study is presented pairing Mini-Circuits' PHA-1+ wideband MMIC amplifier with MMIC equalizer EQY-6-63+, and test data is provided to illustrate the combined response of the pair.

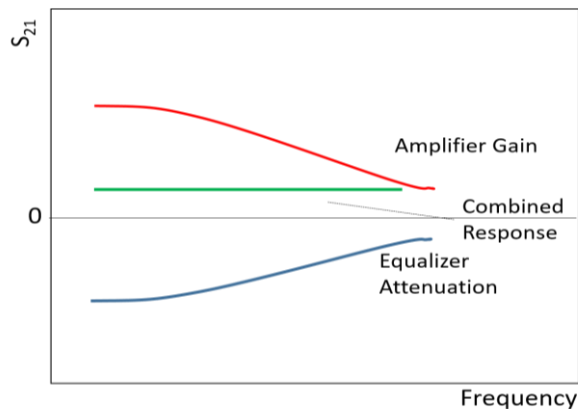

Figure 1a: Combining an amplifier and equalizer with the same dB slope value to create a flat gain response across frequency.

II. Managing Negative Gain Slope

Most general purpose MMIC amplifiers operate over wide bandwidths, covering multiple application bands. Such amplifiers often exhibit a gain response that decreases with frequency. This is especially true for wideband amplifiers with high gain. Negative gain slope can be a major limitation for broadband applications which require consistent gain performance across wide frequency ranges. Undesirable slope in the gain vs. frequency response may be exacerbated by cascading such amplifiers in series, which is a common technique to increase overall gain.

One way to get around the problem is to use different amplifiers for different frequency bands with specific gain values in narrow bandwidths. However, limitations on cost, component count, and board space all make this piecewise approach impractical, and it is usually preferable to use one device with flat gain over a wide bandwidth. This is where equalizers come in. Cascading an equalizer with a wideband amplifier cancels the amplifier gain variation to create a gain-flattening response. One tradeoff is that some gain will be sacrificed for flatness over a wider usable bandwidth. Additionally, adding the equalizer at the amplifier input will sacrifice some noise figure performance, while adding it at the output will sacrifice some output power, and the user must determine which parameter is a higher priority for overall system performance.

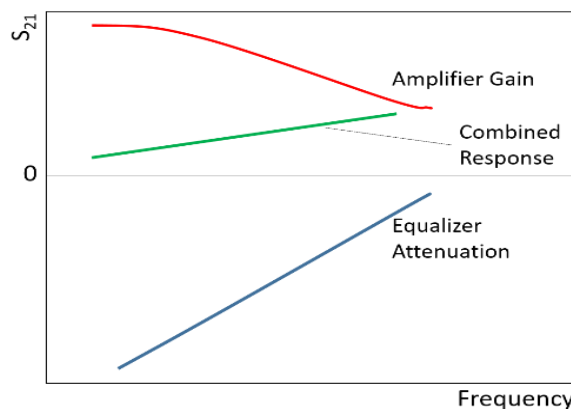

Figure 1b: Combining an amplifier and equalizer with different slope values to create a net positive gain slope response. This technique may be used to compensate for the cascaded effects of other elements in the system chain.

III. The Different Types of Equalizers

There are four basic types of equalizers available, each of which may be appropriate depending on the specific application and the amplifier being used:

- **Positive Slope Equalizers (Figure 2)** exhibit an insertion loss response with a positive slope vs. frequency. This type of equalizer is used to equalize amplifiers or systems with positive gain slope.
- **Negative Slope Equalizers (Figure 3)** exhibit an insertion loss response that decreases with frequency. This type of equalizer is used to equalize amplifiers or systems with negative gain slope, as in the example below.
- **Positive Parabolic Equalizers (Figure 4)** have an insertion loss response that increases in a parabolic shape as frequency increases. These are used to equalize gain variation in systems that have high gain at the band edges and low gain near the center frequency.
- **Negative Parabolic Equalizers (Figure 5)** exhibit insertion loss that decreases in a parabolic shape as frequency increases, and are used to equalize gain variation in systems that have low gain at the band edges but high gain at mid-band.

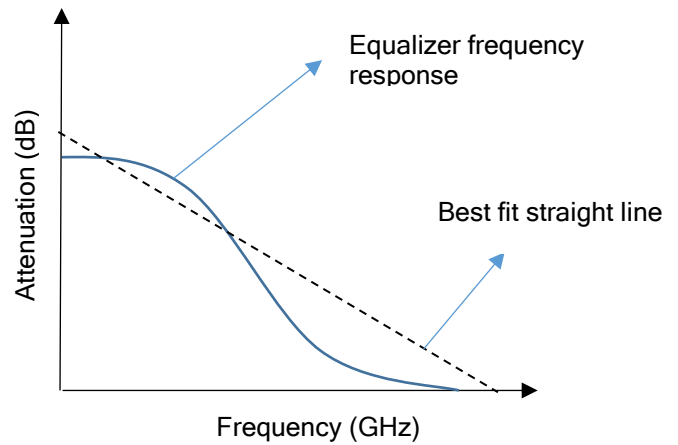

Figure 3: Negative slope equalizer

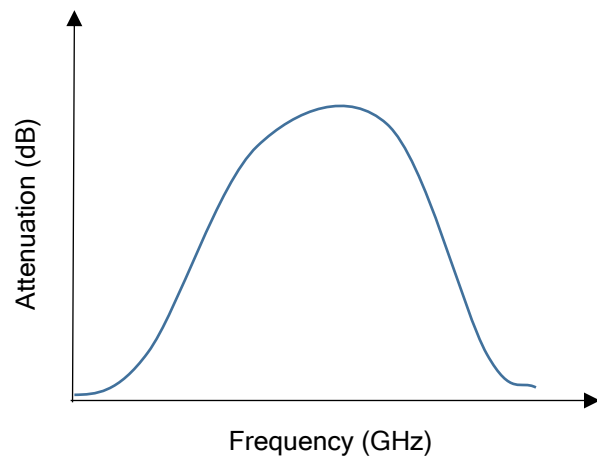

Figure 4: Positive parabolic equalizer

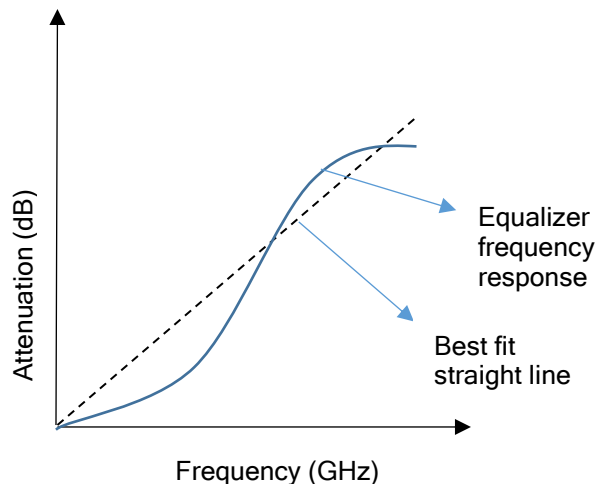

Figure 2: Positive slope equalizer

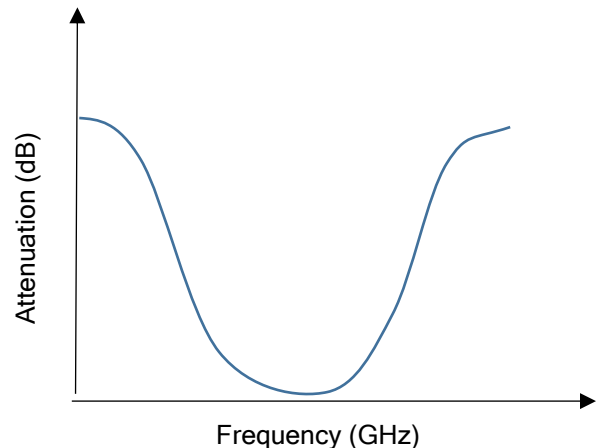

Figure 5: Negative parabolic equalizer

IV. Case Study: Pairing PHA-1+ MMIC Amplifier with EQY-6-63+ Negative Fixed Slope Equalizer

To demonstrate how equalizers can be used to produce a flat gain response from wideband amplifiers, in this example we pair the PHA-1+ high-dynamic range MMIC amplifier with the EQY-6-63+ MMIC fixed equalizer. Mini-Circuits' EQY-series of MMIC negative fixed slope equalizers is available in a range of dB slopes from 1 to 10 dB, allowing users to choose the proper value for the desired combined response with their amplifier. Responses of models EQY-2-63+ (Figure 6) and EQY-6-63+ (Figure 7) shown below exhibit 2 dB and 6 dB slopes, respectively. Additional benefits of these models are the excellent return loss (20 dB typ.), outstanding power handling (+31 dBm typ.) and small package size (2 x 2mm).

The PHA-1+ amplifier boasts an operating frequency range from 0.5 to 6 GHz, but its gain varies from 16.5 dB at 100 MHz to 10 dB at 6 GHz. The EQY-6-63+ equalizer model has an insertion loss varying from 7 dB at 100 MHz to 0.5 dB at 6 GHz, which makes it an excellent companion for the negative gain slope of the amplifier. We expect the

combined response to equalize the gain of the PHA-1+ to a flat value of around 9.5 to 10 dB.

The test setup shown in Figure 8 was used to test the combined response of the amplifier and equalizer together. Evaluation boards for each unit were cascaded in series with the equalizer at the amplifier output and connected to a vector network analyzer. Gain and Return Loss were swept over frequency. To counter any variation in testing, 5 units of PHA-1+ and 3 units of EQY-6-63+ were taken into account. The eval boards for the amplifier and equalizer are shown in Figures 9a and 9b and are available from stock for customers' testing needs.

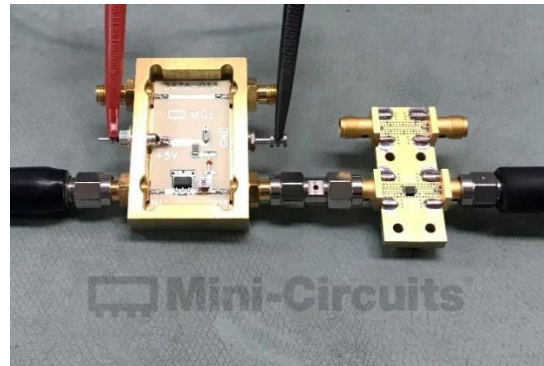

Figure 8: Test setup for PHA-1+ and EQY-6-63+

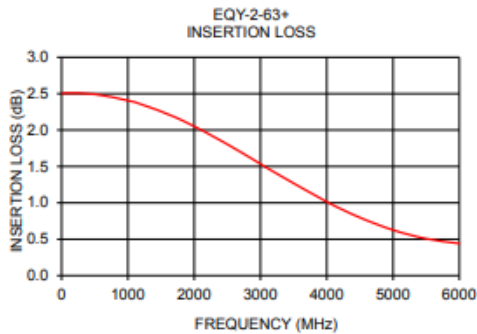

Figure 6: Insertion loss response for EQY-2+ MMIC equalizer with -2 dB slope.

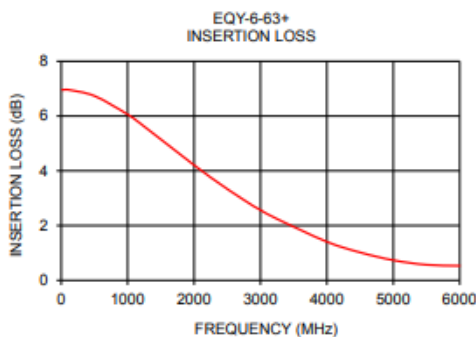

Figure 7: Insertion loss response for EQY-6+ MMIC equalizer with -6 dB slope.

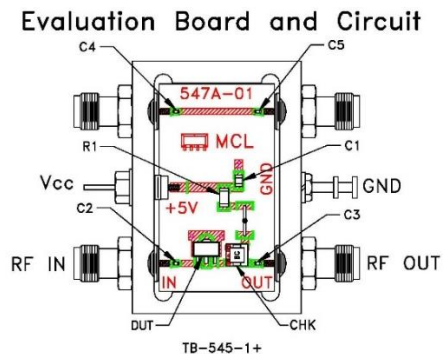

Figure 9a: Evaluation board for PHA-1+ MMIC Amplifier

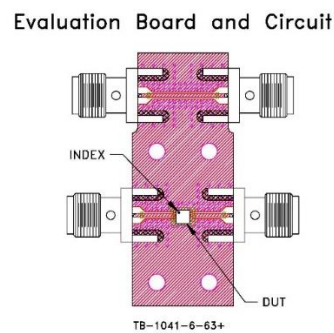

Figure 9b: Evaluation board for EQY-6-63+

5.0 Test Data

Figures 10 and 11 show the measured insertion loss response of the EQY-6-63+ equalizer with a negative slope of about 6 dB and the gain response of the PHA-1+ amplifier, also with a negative slope of roughly 6 dB. We expect the higher loss at the low end of the equalizer response to flatten the higher gain at the low end of the amplifier response, resulting in flatter overall performance over the 0.5 to 6 GHz range.

Figure 12 shows the measured frequency response PHA-1+ and EQY-6-63+ combined in series on the test board. Note the flat response with mid-band gain of 10 dB and minimal variation of +/-0.6dB across the entire 0.5 to 6 GHz range. This result bears out the expected effect based on the individual responses of the amplifier and equalizer.

Figures 13 and 14 illustrate that the input and output return loss of the cascaded pair are better than or equal to that of the amplifier when used alone. This is due to the excellent return loss of the EQY-6-63+ and great matching over the full bandwidth. The plots in Figure 15 show a comparison of the gain response of the amplifier alone vs. the amplifier-equalizer pair, effectively compensating for the negative gain slope of the amplifier.

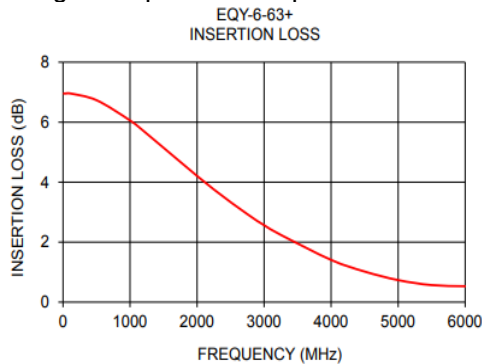

Figure 10: Negative insertion loss slope (6 dB) for EQY-6-63+ MMIC equalizer

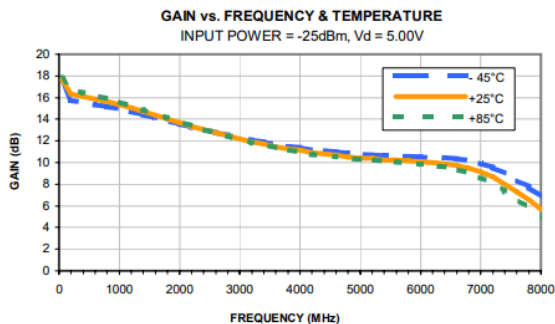

Figure 11: Negative gain slope response for PHA-1+ MMIC amplifier, exhibiting 12 dB gain at mid-band and ± 4 dB variation

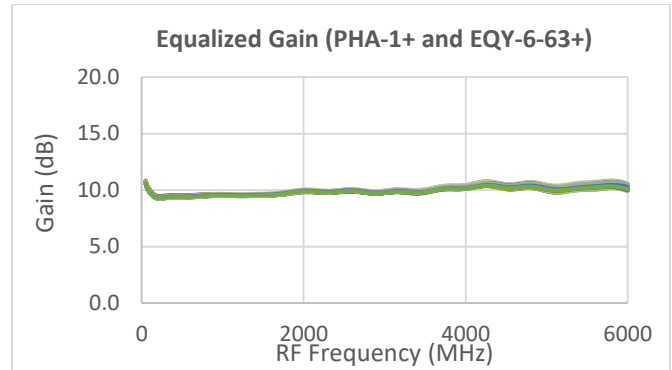

Figure 12: Combined response of PHA-1+ and EQY-6-63+ in series.

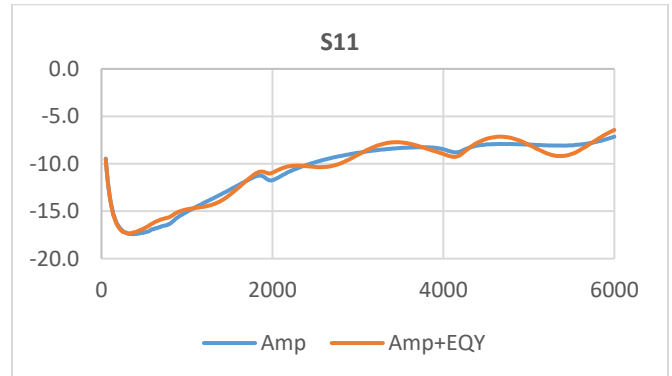

Figure 13: Comparison of input return loss for amplifier alone vs. amplifier-equalizer combination.

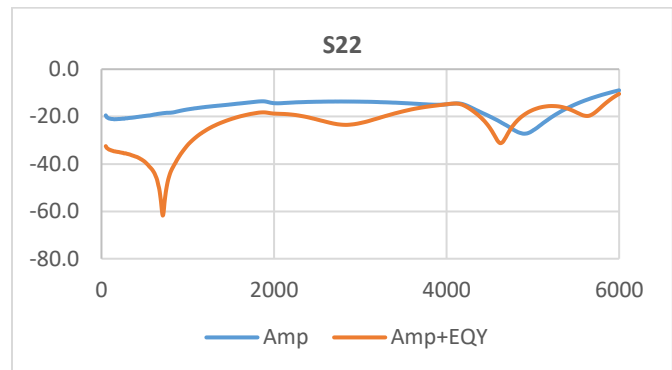

Figure 14: Comparison of output return loss for amplifier alone vs. amplifier-equalizer combination.

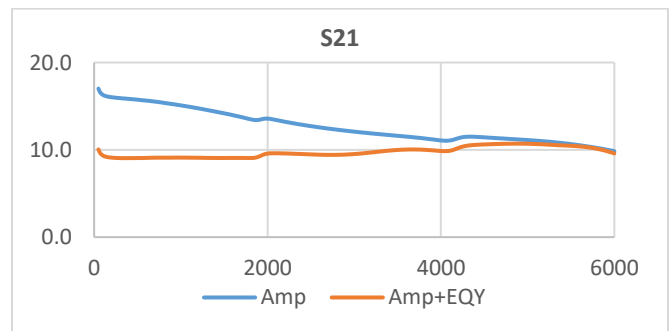

Figure 15: Comparison of gain response for amplifier alone vs. amplifier equalizer combination.

6.0 Conclusion

Among all units tested, average flatness of equalized gain fell within ± 1.3 dB. The PHA-1+ has a gain variation of 6 dB from 100 MHz-6000 MHz. By using the EQY-6-63+ in series with the PHA-1+, we were able to compensate for the gain variation with the negative 6 dB insertion loss slope of the equalizer. The EQY-6-63+ is therefore an excellent match to be used alongside the PHA-1+ amplifier in order to obtain a wideband, flat gain response.

This is just one example of how equalizers can be used to flatten gain response in wideband systems. Additional recommended amplifier-equalizer pairs are provided in the next section. For additional support determining how Mini-Circuits MMIC equalizers may be used with different circuit elements and RF chains, please contact apps@minicircuits.com.

6.0 Other Recommended Amplifier-Equalizer Pairs

As an additional example of matches that lead to optimal results, we recommend the following:

Table 1: Additional recommended amplifier-equalizer pairs

Amplifier	Equalizer
GVA-62+	EQY-2-63+
GALI-19+	EQY-2-63+
GVA-81+	EQY-3-63+
GVA-63+	EQY-5-63+
PGA-102+	EQY-6-63+
GVA-83+	EQY-8-63+
CMA-84+	EQY-10-63+

IMPORTANT NOTICE

© 2017 Mini-Circuits

This document is provided as an accommodation to Mini-Circuits customers in connection with Mini-Circuits parts only. In that regard, this document is for informational and guideline purposes only. Mini-Circuits assumes no responsibility for errors or omissions in this document or for any information contained herein.

Mini-Circuits may change this document or the Mini-Circuits parts referenced herein (collectively, the "Materials") from time to time, without notice. Mini-Circuits makes no commitment to update or correct any of the Materials, and Mini-Circuits shall have no responsibility whatsoever on account of any updates or corrections to the Materials or Mini-Circuits' failure to do so.

Mini-Circuits customers are solely responsible for the products, systems, and applications in which Mini-Circuits parts are incorporated or used. In that regard, customers are responsible for consulting with their own engineers and other appropriate professionals who are familiar with the specific products and systems into which Mini-Circuits' parts are to be incorporated or used so that the proper selection, installation/integration, use and safeguards are made. Accordingly, Mini-Circuits assumes no liability therefore.

In addition, your use of this document and the information contained herein is subject to Mini-Circuits' standard terms of use, which are available at Mini-Circuits' website at www.minicircuits.com/homepage/terms_of_use.html.

Mini-Circuits and the Mini-Circuits logo are registered trademarks of Scientific Components Corporation d/b/a Mini-Circuits. All other third-party trademarks are the property of their respective owners. A reference to any third-party trademark does not constitute or imply any endorsement, affiliation, sponsorship, or recommendation: (i) by Mini-Circuits of such third-party's products, services, processes, or other information; or (ii) by any such third-party of Mini-Circuits or its products, services, processes, or other information.